

14A4SS125DB

Square Direct Burial Aluminum Light Pole 14 Foot Above Grade, 4 Inch Wide, 0.125 Inch Wall Thickness



Job: _____
 Job Site: _____ State: _____ Client Name: _____
 Notes: _____ Approvals: _____ Date: _____

Pole Top Options: A removable pole cap or open top are standard options. Available tenon diameter options are: 2-3/8 in. or 3 in. Both tenon options are 4 in. long.

Pole Shaft: 14 ft. height above ground, 4 in. square straight aluminum with 0.125 in. wall thickness. The pole shaft is constructed of seamless extruded tube of 6063 Series Aluminum Alloy per the requirements of ASTM B221.

Handhole: 2 in. X 4 in. handhole is located 12 in. above ground. Handhole cover with 2 screws is provided. A ground lug with set screw is located near the handhole opening for proper grounding of the pole.

Embedment: Embedment length is 3 ft. Wire access is provided 18" below ground line.

Finish: Commercial grade, super durable powder coat finish. Dark Bronze is standard color. Black, White, Gray colors are available with extended lead times and additional surcharge.

Warranty: 10 Years.

Foundation design: Foundation should be designed by an engineer familiar with local soil and wind conditions as well as local code where the pole(s) will be installed.

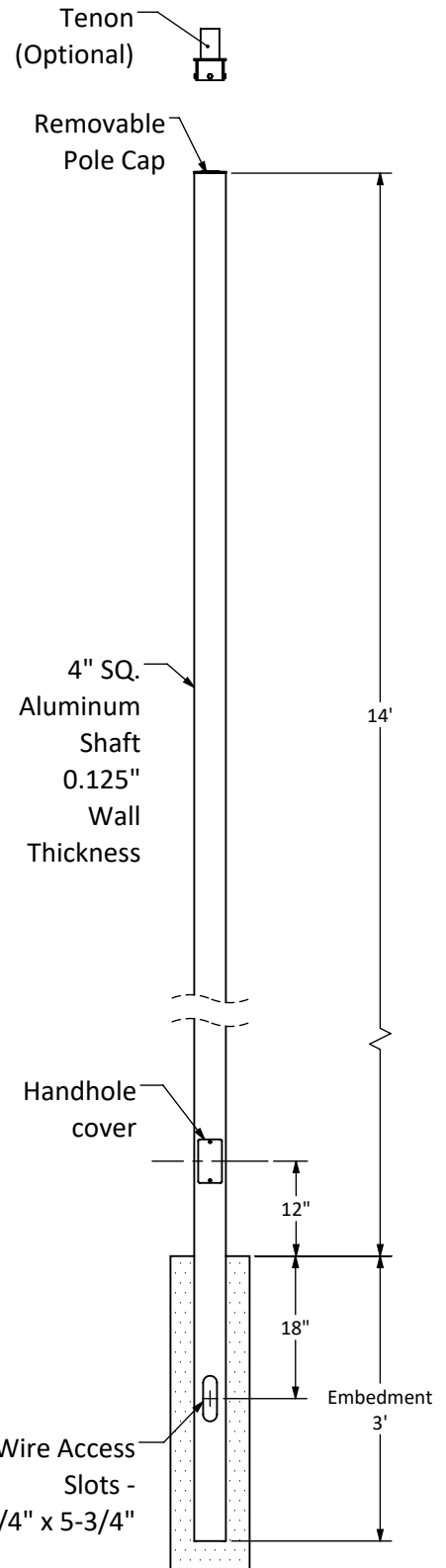

POLE WIND RATING (EPA) with 1.3 Gust Factor					POLE LENGTH AND WEIGHT		
70 mph	80 mph	90 mph	100 mph	110 mph	Embedment (ft)	Total Length (ft)	Weight (lbs)
10.2	7.1	4.9	3.4	2.4	3	17	39



Disclaimer: All dimensions and specifications are subject to change without any notice. Energy Light, Inc. is not responsible for any claims arising from improper loading (what is attached to the light pole), improper use, incorrect foundation design and/or installation.