

# 16A4SS125

# 16 Foot Square Straight Aluminum Light Pole, 4 Inch Wide, 0.125 Inch Wall Thickness



Job: \_\_\_\_\_ Client Name: \_\_\_\_\_  
 Job Site: \_\_\_\_\_ State: \_\_\_\_\_ Approvals: \_\_\_\_\_  
 Notes: \_\_\_\_\_ Date: \_\_\_\_\_

**Pole Top Options:** A removable pole cap or open top are standard options. Available tenon diameter options are: 2-3/8 in. or 3 in. Both tenon options are 4 in. long.

**Pole Shaft:** 16 ft. height above ground, 4 in. square straight aluminum with 0.125 in. wall thickness. The pole shaft is constructed of seamless extruded tube of 6063 Series Aluminum Alloy per the requirements of ASTM B221.

**Handhole:** 2 in. X 4 in. handhole is located 18 in. above ground. Handhole cover with 2 screws is provided. A ground lug with set screw is located near the handhole opening for proper grounding of the pole.

**Anchor Bolts:** A set of 4 galvanized steel anchor bolts is provided with each pole assembly. Each anchor bolt includes 1 Hex Nut, 1 Lock Washer and 1 Flat Washer. Energy Light, Inc. recommends leveling shims instead of leveling nuts. No grouting is required with leveling shims. Shims are available at a surcharge. An actual size paper anchor bolt template is provided.

**Bolt Circle Range:** 8 1/2 in. - 9 1/2 in.

**Base:** Cast Aluminum base flange of alloy 356-T6 with snap-in bolt covers.

**Finish:** Commercial grade, super durable powder coat finish. Dark Bronze is standard color. Black, White, Gray colors are available with extended lead times and additional surcharge.

**Other Options:** The following options are available with extended lead times and surcharges:  
 Vibration damper, custom tenon sizes, custom colors, electric/GFI outlets, custom pole heights, additional handhole and UL compliant handholes.

**Warranty:** 10 Years

**Foundation design:** Foundation should be designed by an engineer familiar with local soil and wind conditions as well as local code where the pole(s) will be installed.

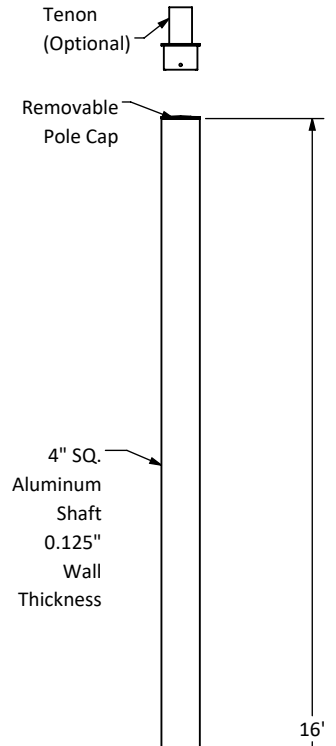

Maximum EPA with 1.3 Gust Factor (ft <sup>2</sup> )					Pole Weight (lbs)
90 mph	100 mph	110 mph	120 mph	130 mph	
8.8	6.4	5.8	4.4	3.2	45

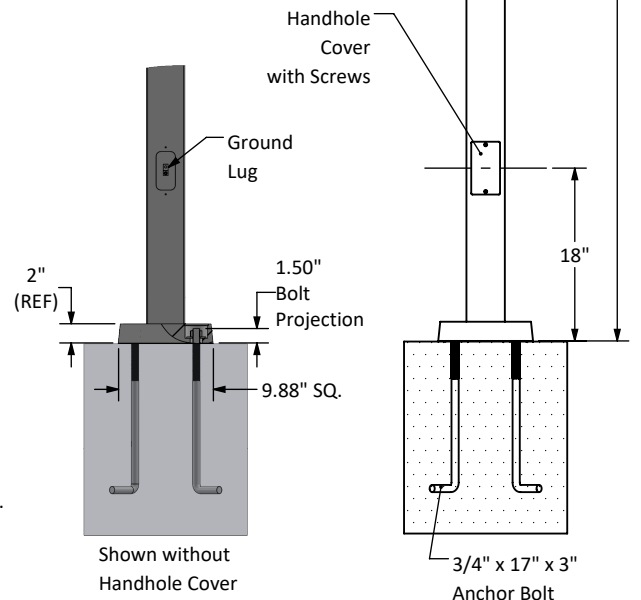
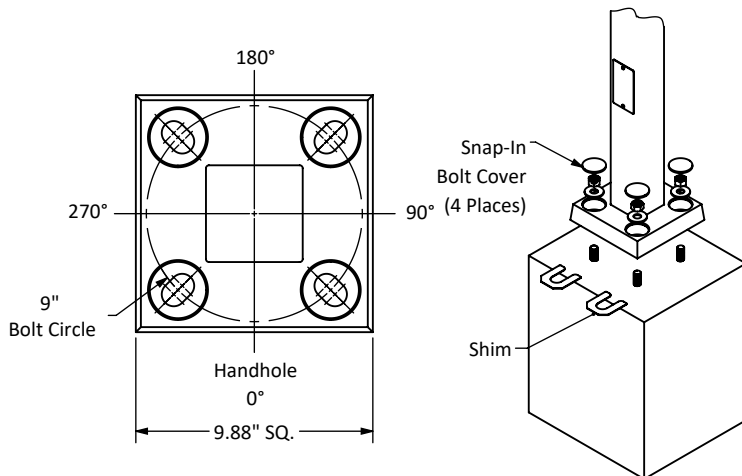

**Disclaimer:** All dimensions and specifications are subject to change without any notice. Energy Light, Inc. is not responsible for any claims arising from improper loading (what is attached to the light pole), improper use, incorrect foundation design and/or installation.