

30S05RS188

30 Foot Round Straight Steel Light Pole, 5 Inch Diameter, 7 Gauge



Job: _____
 Job Site: _____ State: _____ Client Name: _____
 Notes: _____ Approvals: _____ Date: _____

Pole Top Options: A removable pole cap is provided if the pole is drilled for attaching light fixtures. The drill pattern and drill orientation needs to be provided by the customer unless Energy Light fixtures are used for the project. If tenon option is selected, a 2-3/8 inch diameter tenon with 4 inch length is provided.

Pole Shaft: Pole shaft shall be weldable-grade, cold-rolled, commercial quality carbon steel tubing conforming to ASTM standards. Pole height is 30 ft.

Handhole: Reinforced, 3" x 5" Handhole with cover, stainless steel screw and backbar is located at 18 inches from the base. Ground lug is included.

Finish: Commercial grade, super durable powder coat finish. Dark Bronze, White, Black, Gray colors are provided at no extra charge. Other colors and custom colors are available with extended lead times and additional surcharge.

Anchor Bolts: A set of 4 galvanized steel anchor bolts specifically designed for this light pole is required for each pole assembly. Each anchor bolt includes 2 nuts and 2 washers. The top portion of the anchor bolt is threaded for securing and leveling the pole with the provided nuts and washers. An actual size paper anchor bolt template is provided.

Bolt Circle: 11" (Bolt Circle Range 10"-12")

Base Cover: Two-piece steel square base cover is required for protecting pole base from elements. Stainless steel screws are included to attach the 2 pieces together after pole installation.

Other Options: The following options are available at an extra charge:
 Custom tenon sizes, custom colors, electric/GFI outlets, custom pole heights, additional handholes and custom base plate dimensions.

Warranty: 1 Year.

Foundation design: Foundation should be designed by an engineer familiar with local soil and wind conditions as well as local code where the pole(s) will be installed.

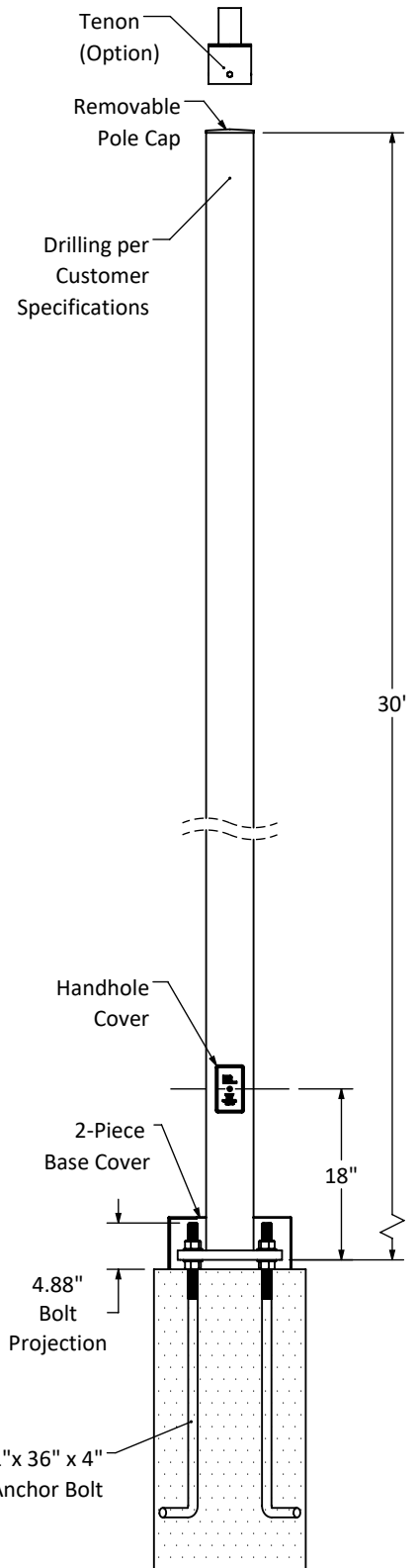

Maximum EPA with 1.3 Gust Factor (ft ²)						Pole Weight (lbs)
90 mph	100 mph	110 mph	120 mph	130 mph	140 mph	
7.0	4.5	4.0	3.1	2.4	1.8	321

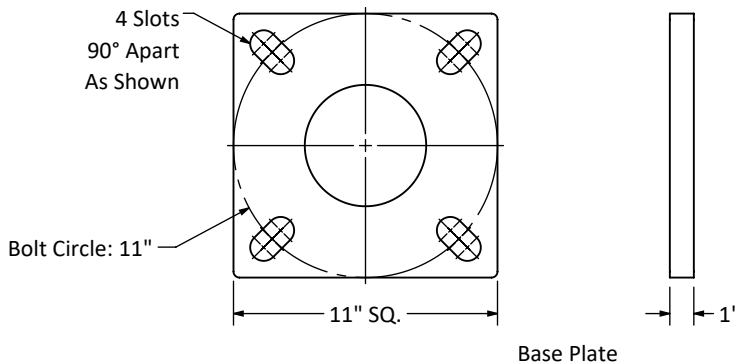

Disclaimer: All dimensions and specifications are subject to change without any notice. Energy Light LLC is not responsible for any claims arising from improper loading (what is attached to the light pole), improper use, incorrect foundation design and/or installation.