

547091

16 Foot Square Steel Light Pole, 4 Inch Wide, 11 Gauge



Job: _____
 Job Site: _____ State: _____ Client Name: _____
 Notes: _____ Approvals: _____ Date: _____

Pole Top Options: A removable pole cap is provided if the pole is drilled for attaching light fixtures. The drill pattern and drill orientation needs to be provided by the customer unless Energy Light fixtures are used for the project. If tenon option is selected, a steel tenon will be provided.

A 2 3/8 inch diameter tenon with 4 inch length is standard; however, the customer needs to confirm the appropriate tenon size required for the project.

Pole Shaft: 4 inch square 11 gauge commercial grade steel conforms to ASTM standards. Pole height is 16 ft.

Handhole: 3" X 5" size reinforced handhole is located at 18 inches from the base. A ground lug with set screw is located near the handhole opening for proper grounding of the pole.

Finish: Commercial grade, super durable powder coat finish. Dark Bronze is standard color. Black, White, Gray colors are available with additional surcharge.

Anchor Bolts: A set of 4 galvanized steel anchor bolts specifically designed for this light pole is required for each pole assembly. Each anchor bolt includes 2 nuts and 2 washers. The top portion of the anchor bolt is threaded for securing and leveling the pole with the provided nuts and washers. An actual size paper anchor bolt template is provided.

Bolt Circle: 8-1/2" (Bolt Circle Range 8"-11")

Base Cover: Two piece ABS plastic base cover is required for protecting pole base from elements.

Other Options: The following options are available:

Vibration dampener, custom tenon sizes, custom colors, custom pole heights, additional handholes.

Warranty: 1 Year.

Foundation design: Foundation should be designed by an engineer familiar with local soil and wind conditions as well as local code where the pole(s) will be installed.

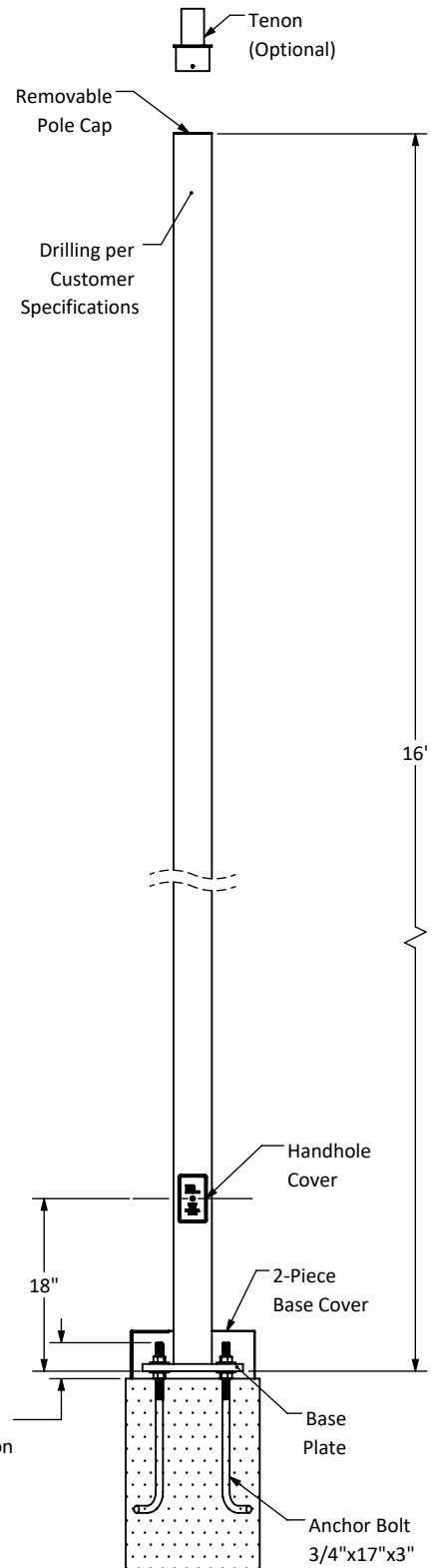

Maximum EPA with 1.3 Gust Factor (ft ²)								Pole Weight (lbs)
110 mph	120 mph	130 mph	140 mph	150 mph	160 mph	170 mph	180 mph	
8.2	6.4	4.9	3.8	2.9	2.1	1.5	1.0	116

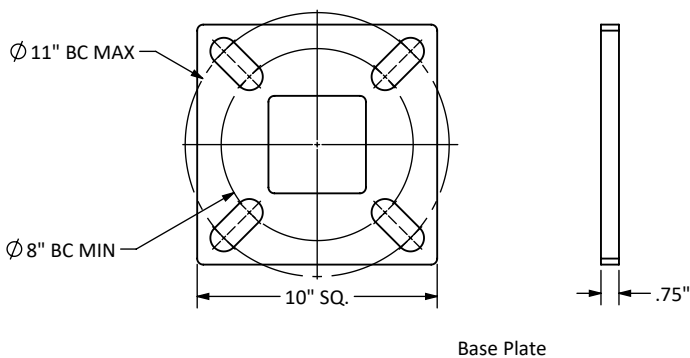

Disclaimer: All dimensions and specifications are subject to change without any notice. Energy Light LLC is not responsible for any claims arising from improper loading (what is attached to the light pole), improper use, incorrect foundation design and/or installation.