

8116HIC-20

120V-277V

Catalog #:		Type
Project:		Date
Prepared by:		

6" IC Recessed LED Down Light

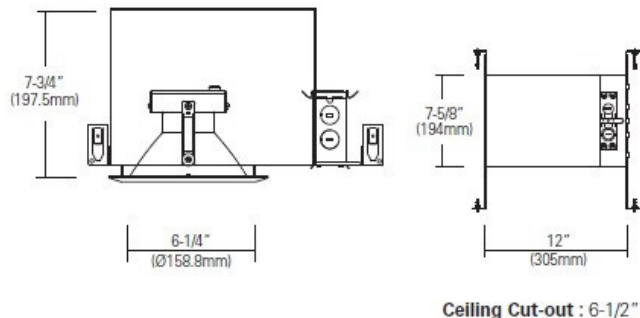

DESCRIPTION

An ideal solution for affordability, efficiency, safety, and flexible design aesthetics. The 8116HIC housing - module/trim combo balances power, efficiency and cost to bring you the options needed to complete a variety of residential or commercial projects with a reliable and modern LED down light solution.

DESIGN FEATURES

Housing

- Sturdy aluminum construction
- IC rated, suitable for direct contact with insulation
- Wet location rated when used with 8570 module/trim
- Suitable for use in new construction applications
- 7 3/4" height allows for use in 2" x 8" joist construction
- Meets Washington's State energy code for restricted airflow

Junction Box

- Listed for through branch circuit wiring and includes several 3/4" knockouts
- Easy access plate for quick wiring

Hanger Bars

- Heavy-gauge captive hanger bars allow the housing to be secured to both joist or suspended "T" bar construction
- Adjustable to position the housing at any point within a 24" joist span or grid section.
- 4 captive nails for quick placement

Electrical

- Universal voltage: 120-277V
- Triac dimming with integral driver
- Suitable for use in damp locations
- 50,000 hour projected life
- 1,500Lm | 23W | 65Lm/W
- Available in 3000 or 4000K

Emergency Option

- 8116HIC-20-EM

Certifications

- cETLus
- 5 year limited warranty

Available LED Modules/Trim Finishes

- 8570__-20-_K (WH or BK | 3K or 4K)
- 8570FS-20-_K (Fresnel | 3K or 4K)
- 8571HZ-20-_K (Haze | 3K or 4K)
- 8572__-20-_K (Eyeball | WH or BK | 3K or 4K)
- 8573WH-20-_K (Gimbal | WH | 3K or 4K)



TEL: 800.937.6925 | Fax: 800.207.9509 | www.rplighting.com

Specifications and dimensions subject to change without notice.

8116HIC-20

120V-277V

Specification & Ordering

HOUSING

Example: 8116HIC-20-EM

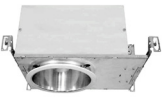
Housing #	Wattage		Emergency Battery Backup	
 8116HIC				
8116HIC	-20	: 20W	-EM	: 4731EM Emergency Battery

MODULE/TRIM

Example: 8570WH-20-3K

Module/Trim #	Finish		Watts		CCT	
 8570						
8570	WH	: White	-20	: 20W	-3K	: 3000 K
	BK	: Black			-4K	: 4000 K

Example: 8570FS-20-4K

Module/Trim #	Finish		Watts		CCT	
 8570						
8570	FS	: Fresnel	-20	: 20W	-3K	: 3000 K
					-4K	: 4000 K

Example: 8571HZ-20-3K

Module/Trim #	Finish		Watts		CCT	
 8571						
8571	HZ	: Haze	-20	: 20W	-3K	: 3000 K
					-4K	: 4000 K

Example: 8572WH-20-4K

Module/Trim #	Finish		Watts		CCT	
 8572						
8572	WH	: White	-20	: 20W	-3K	: 3000 K
	BK	: Black			-4K	: 4000 K

Example: 8573WH-20-3K

Module/Trim #	Finish		Watts		CCT	
 8573						
8573	WH	: White	-20	: 20W	-3K	: 3000 K
					-4K	: 4000 K

TEL: 800.937.6925 | Fax: 800.207.9509 | www.rplighting.com

Specifications and dimensions subject to change without notice.