

# 8202HA Series

120V-60Hz

Catalog #:		Type
Project:		Date
Prepared by:		

## 4" IC Airtight Frame-In

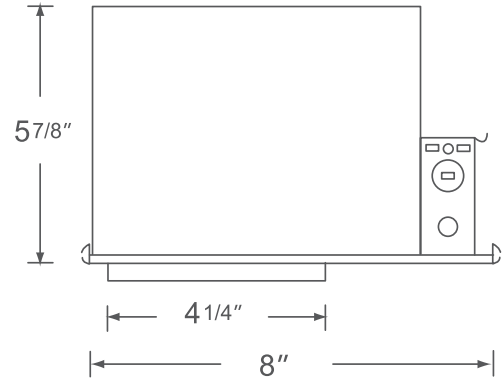
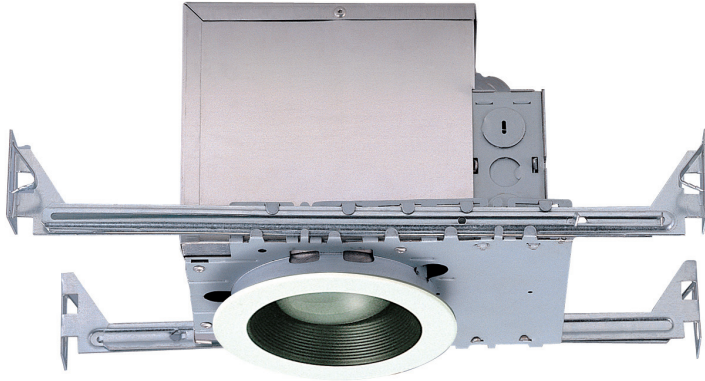

### DESCRIPTION

This 8202HA Series airtight aluminum housing is insulation contact rated. The housing is suitable for new construction in both residential and commercial applications. Features thermal protector guards, adjustable hangar bars for easy installation.

### DESIGN FEATURES

#### Electrical

- 120V-60Hz
- Incandescent, 50W Max (35W with cellulose type insulation)

#### Housing

- Sturdy aluminum construction
- IC Rated for direct contact with batt type fiberglass insulation
- Thermally protected against improper lamping
- Adjusts to accommodate up to 1" ceiling thickness
- 5-7/8" height allows use in 2" x 6" joist construction
- Adjustable socket bracket plate for proper positioning of different lamp types
- cCSAus listed for damp location and feed through wiring

#### Junction Box

- J-box is listed for through-branch circuit wiring, (4in-4out) and seven 1/2" knockouts
- 3-port quick connectors pre-installed in all J-boxes

#### Bar Hanger

- Pre-installed bar hangers allow the housing to be positioned at any point within 24" joist span
- Pre-installed captive nails on bar hangers
- Bar hangers can be turned 90° on the plaster frame
- Bar hangers are designed to fit T-bar spine without additional clamps for use in drop ceilings

#### Dimensions

- H 5-7/8" x L 8" x W 5-3/4"
- Aperture: 4-1/4"

#### Certifications

- cCSAus certified for damp location
- 1 year limited warranty

#### Lamp

- R20
- PAR20



TEL: 800.937.6925 | Fax: 800.207.9509 | [www.rplighting.com](http://www.rplighting.com)

Specifications and dimensions subject to change without notice.

# 8202HA Series

120V-60Hz

## Specification & Ordering

### HOUSING

Example: 8202HA

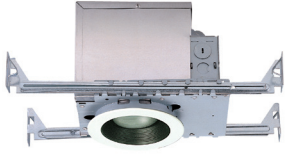
Housing #	Wattage	
 8202HA		
8202HA	50 Max (trim Permitting)	:

### LED Trims

#### MODULE/TRIM

Example: 8722WH

Module/Trim #	Finish	
 8722		
8722 10W, 650lms 90 CRI 3000K/4000K	WH	: White

#### MODULE/TRIM

Example: 8765WH

Module/Trim #	Finish	
 8765		
8765 8W, 600lms 3000K	WH	: White
	BN	: Brushed Nickel
	OB	: Bronze

#### MODULE/TRIM

Example: 8756WH-R

Module/Trim #	Finish	
 8756__-R		
8756__-R 12W, 730lms 80/90 CRI 2700K, 3000K, 4000K	WH	: White
	BN	: Brushed Nickel
	BK	: Black
	OB	: Bronze

#### MODULE/TRIM

Example: 8767WH

Module/Trim #	Finish	
 8767		
8767 10W, 900lms 90 CRI 3000K	WH	: White
	BN	: Brushed Nickel
	OB	: Bronze

#### MODULE/TRIM

Example: 8761OB

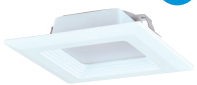
Module/Trim #	Finish	
 8761		
8761 9W, 630lms 90 CRI 3000K	OB	: Bronze
	BA	: Brushed Aluminum

#### MODULE/TRIM

Example: 8768WH

Module/Trim #	Finish	
 8768		
8768 10W, 900lms 3000K	WH	: White
	BN	: Brushed Nickel
	OB	: Bronze

#### MODULE/TRIM

Example: 8763WH

Module/Trim #	Finish	
 8763		
8763 10W, 90 CRI 3000K/4000K 600lms	WH	: White
	BN	: Brushed Nickel
	BK	: Black
	OB	: Bronze
	CL	: Clear

#### MODULE/TRIM

Example: 8769WH

Module/Trim #	Finish	
 8769		
8769 10W, 3000K/4000K 82CRI: 895lms 92CRI: 717lms	WH	: White
	BK	: Black
	BN	: Brushed Nickel
	OB	: Bronze

TEL: 800.937.6925 | Fax: 800.207.9509 | [www.rplighting.com](http://www.rplighting.com)

Specifications and dimensions subject to change without notice.

# 8202HA Series

120V-60Hz

## Specification & Ordering

### LED Trims

**MODULE/TRIM** Example: 8770CL

Module/Trim #	Finish
	<b>8770</b>
	<b>8770</b> 10W, 3000K, 4000K 81CRI: 889lms 92CRI: 710lms <b>CL</b> : Clear

**MODULE/TRIM** Example: 8771WH

Module/Trim #	Finish
	<b>8771</b>
	<b>8771</b> 10W, 3000K/4000K 81CRI: 887lms 92CRI: 710lms <b>WH</b> : White <b>BN</b> : Brushed Nickel <b>OB</b> : Bronze

**MODULE/TRIM** Example: 8773WH

Module/Trim #	Finish
	<b>8773</b>
	<b>8773</b> 11W, 700lms 90 CRI 3000K/4000K <b>WH</b> : White

### Incandescent Trims

**MODULE/TRIM** Example: 8701WH

Module/Trim #	Finish
	<b>8701</b>
	<b>8701</b> 50W Max. PAR20/R20 <b>WH</b> : White

**MODULE/TRIM** Example: 8702FS

Module/Trim #	Finish
	<b>8702</b>
	<b>8702</b> 35W Max. PAR20/R20 <b>FS</b> : Fresnel

**MODULE/TRIM** Example: 8703WH

Module/Trim #	Finish
	<b>8703</b>
	<b>8703</b> 50W Max. PAR20/R20 <b>WH</b> : White <b>BK</b> : Black <b>CL</b> : Clear

**MODULE/TRIM** Example: 8705AL

Module/Trim #	Finish
	<b>8705</b>
	<b>8705</b> 35W Max. PAR20/R20 <b>AL</b> : Albalite

TEL: 800.937.6925 | Fax: 800.207.9509 | [www.rplighting.com](http://www.rplighting.com)

Specifications and dimensions subject to change without notice.