



Description

Altech's LED Hyper Flood Light, represents the future of energy efficiency in facility illumination. The perfect low-profile, high-performance LED fixture when needed.



*Not all product variations listed on this page are DLC Premium qualified. To ensure that a specific model is qualified, visit www.designlights.org/search

Applications

Ground Mount
Security Lighting

Wall Mount
Roof Mount

Pole Mount

Specs

Efficacy 165 lm/W
Input Voltage 100-277V
Finish Bronze

Details

IP Rating IP67
EPA Rating 0.9
Materials Die Cast Aluminum
Lens Tempered Glass (Minimal Glare)
L70 Life 150,000 Hours
Warranty 10 Years
CRI 70+
Qualification UL, DLC Premium, FCC, CE, RoHS
Whip Length(ft) 1.67'

Electrical

Power Factor 0.99
Frequency 50/60 Hz
Max THD 15%
Operating Temp. -40° F to 150° F
-40 ° C to 65° C
Dimming 3 in 1 (Resistance, PWM, 0-10V)
Optional for 15W-60W;
Standard for 90W-150W

LED Hyper Flood Light

Ordering Information

ORDERING/DLC #:	Wattage	CCT	Lumens	Equivalent
U-HFL-15W-30-D	15W	3000K	2,295 lm	75W MH
U-HFL-15W-40-D	15W	4000K	2,385 lm	75W MH
U-HFL-15W-50-D	15W	5000K	2,475 lm	75W MH
U-HFL-30W-30-D	30W	3000K	4,530 lm	150W MH
U-HFL-30W-40-D	30W	4000K	4,710 lm	150W MH
U-HFL-30W-50-D	30W	5000K	4,890 lm	150W MH
U-HFL-60W-30-D	60W	3000K	9,000 lm	300W MH
U-HFL-60W-40-D	60W	4000K	9,360 lm	300W MH
U-HFL-60W-50-D	60W	5000K	9,720 lm	300W MH
U-HFL-90W-30-D	90W	3000K	13,860 lm	350W MH
U-HFL-90W-40-D	90W	4000K	14,400 lm	350W MH
U-HFL-90W-50-D	90W	5000K	14,940 lm	350W MH
U-HFL-120W-30-D	120W	3000K	18,600 lm	550W MH
U-HFL-120W-40-D	120W	4000K	19,320 lm	550W MH
U-HFL-120W-50-D	120W	5000K	20,040 lm	550W MH
U-HFL-150W-30-D	150W	3000K	22,500 lm	650W MH
U-HFL-150W-40-D	150W	4000K	23,400 lm	650W MH
U-HFL-150W-50-D	150W	5000K	24,300 lm	650W MH

Additional Notes

- 4000K and 5000K, 100-277V are stocked locally, check for ETA's
- Altech Electronics reserves the right to make periodic improvements to our product specs

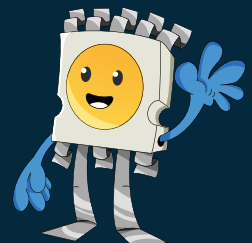

Mounting Options



Knuckle Mount
(available for 15W-60W)



Trunnion Mount
(available for all wattages)

Accessories and Options



Compatible with controls and integrations

Fixture Dimensions and Weight

15, 30, & 60 Watt

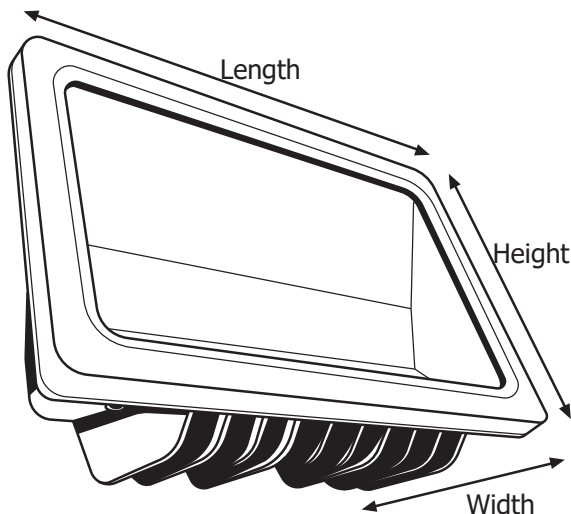

Length	Width	Height	Weight
9.8 in.	3.75 in.	6.25 in.	4 lb.
249 mm.	95 mm.	165 mm.	1.81 kg.

90, 120, & 150 Watt

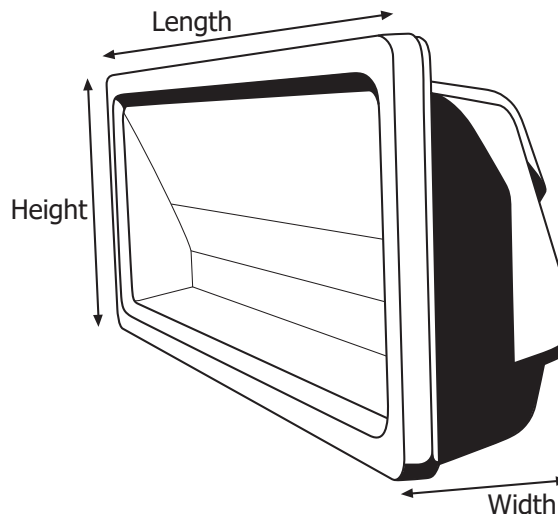

Length	Width	Height	Weight
15.75 in.	3.75 in.	6.25 in.	7 lb.
400 mm.	95 mm.	165 mm.	3.17 kg.

Wiring Precaution

The international color scheme is brown (hot), blue (neutral) and green/yellow (ground) wiring. Always disconnect power when installing or troubleshooting. Consult a licensed technician.

