

CANVAS SERIES

24V DC LED Light Sheet - Tunable CCT

The Canvas Light Sheet is the ideal product for backlighting semi-transparent countertops and architectural features. Cut the 12" x 24" sheet to size at the job site to achieve a perfect fit for your application. Built-in spacers help lift your material a half-inch off the light sheet for a leveled and diffused effect.

- Tunable CCT 2700K to 6000K Color Tuning
- Ideal for backlighting semi-translucent materials
- Up to 1800Lm output performance per sheet
- Available in 12"H x 24"W sheet size
- Field cuttable on-site for an accurate fit
- 2" x 1" Cuttability and LED spacing
- 3M peel and stick backing for quick installation
- Built-in terminal ports make it easy to run power from any side
- Integrated 1/2" stand-offs spaced every 8 inches:
- Each Stand-off is rated up to 35lb load rating (220lbs per sheet)



PROJECT: _____

TYPE: _____

LOCATION: _____

CATALOG NUMBER: _____

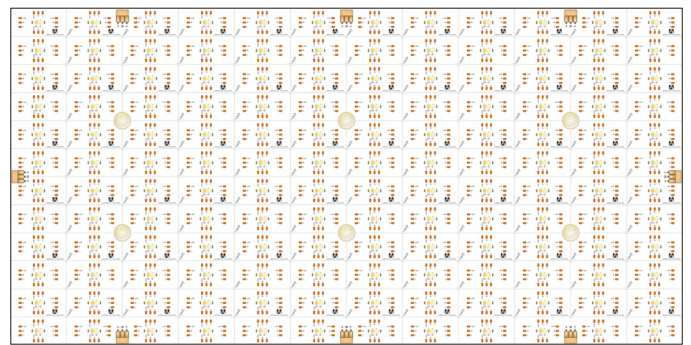
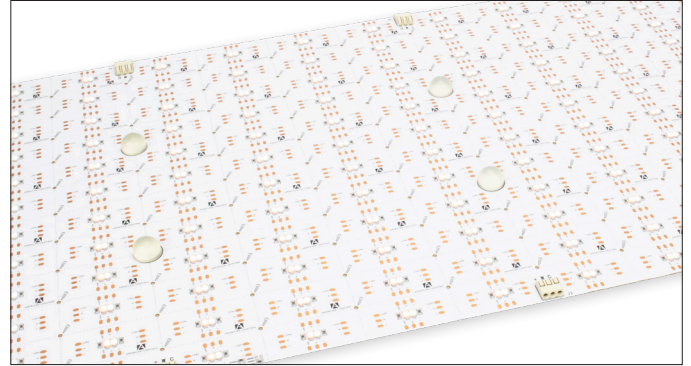

CANVAS TUNABLE SERIES QUICK SPECS	
VOLTAGE	24V DC
WATTAGE	20W per sheet
LUMENS	Up to 1800Lm per sheet
CCT OPTIONS	2700K to 6000K
CRI	90+
MAX RUN	96W (4-1/2 Sheets Total)
CUTTING POINTS	2" x 1"
IP RATING	IP54 (Unjacketed)
DIMMING	5 - 100%
DIMENSIONS	12" (304.8mm) W x 24" (609.6mm) H
BEAM ANGLE	120°
STORAGE TEMP	-20°C (4°F) to 60°C (140°F)
AMBIENT TEMP	-20°C (4°F) to 45°C (113°F)
OPERATING TEMP	-20°C (4°F) to 45°C (113°F)
CERTIFICATIONS	cULus Listed - Maintains UL listing when cut
RATED LIFE	50,000 Hours

CANVAS TUNABLE SERIES ORDERING INFORMATION

ITEM NUMBER	VOLTAGE	CCT	LENGTH	LUMENS	WATTAGE	IP RATING	CRI	CUTTING	MAX RUN
CNVS-TW-12x24	24V DC	2700K-6000K	12" x 24"	1800Lm	20W	IP54	90+	2" X 1"	96W

Includes: (2) 12"x24" Canvas LED Sheets / (1) 24" 20/3 Power Wire / (4) 12" 20/3 Jumper Wires

CANVAS TUNABLE SERIES ACCESSORIES

ITEM NUMBER	DESCRIPTION
CNVS-RPC-3	3-pin Rigid Connector; Bag of 5
CNVS-ICON-3PIN	2" (50mm) In-line 3-pin Jumper Wire
INLINE-TW-CTRL	Simple Select In-line Controller (Tunable CCT)
RCWY-PVC-1M	1m Plastic Wire Cover Raceway

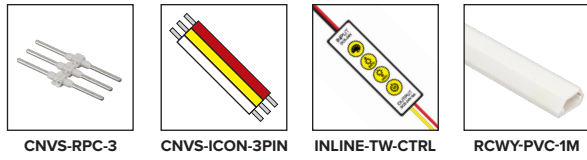

CANVAS TUNABLE SERIES QUICK DIMENSIONS

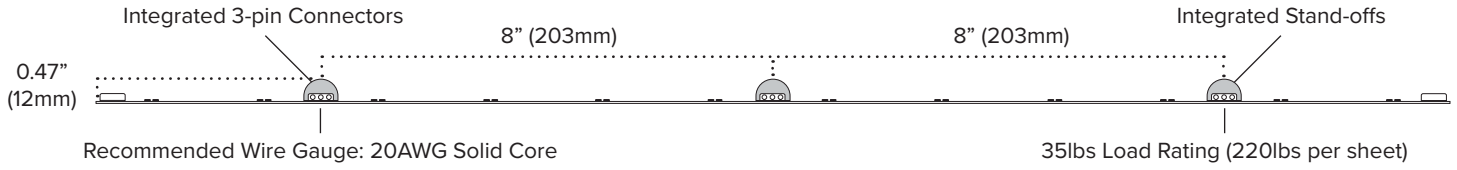

Please Note: When using Tunable CCT Canvas series, the setback needs to be greater than 2-2 1/2 inches. If a build-up cannot be made 2- 2 1/2 inches above the canvas sheets the job will need to be specified with static white canvas sheets.

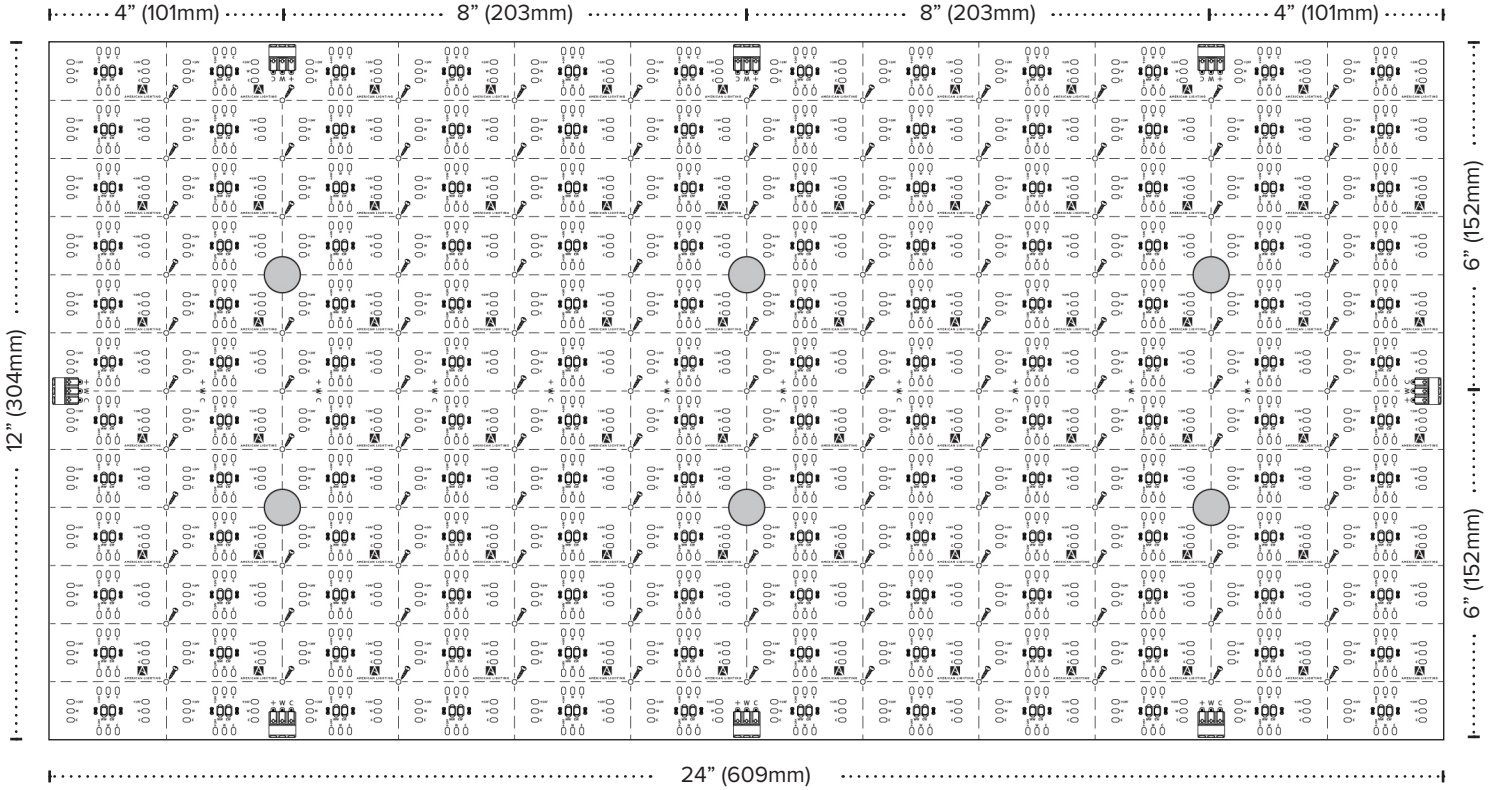

CANVAS TUNABLE SERIES QUICK SET-UP

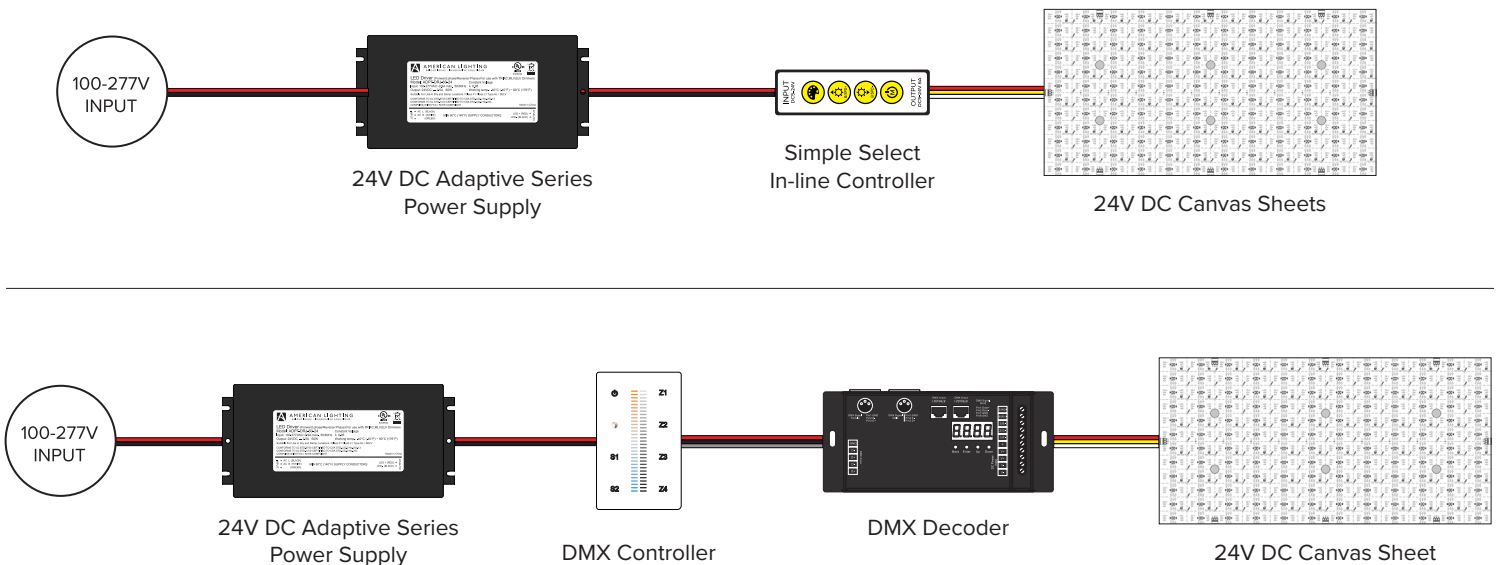

CANVAS TUNABLE SERIES WIRING CONFIGURATION

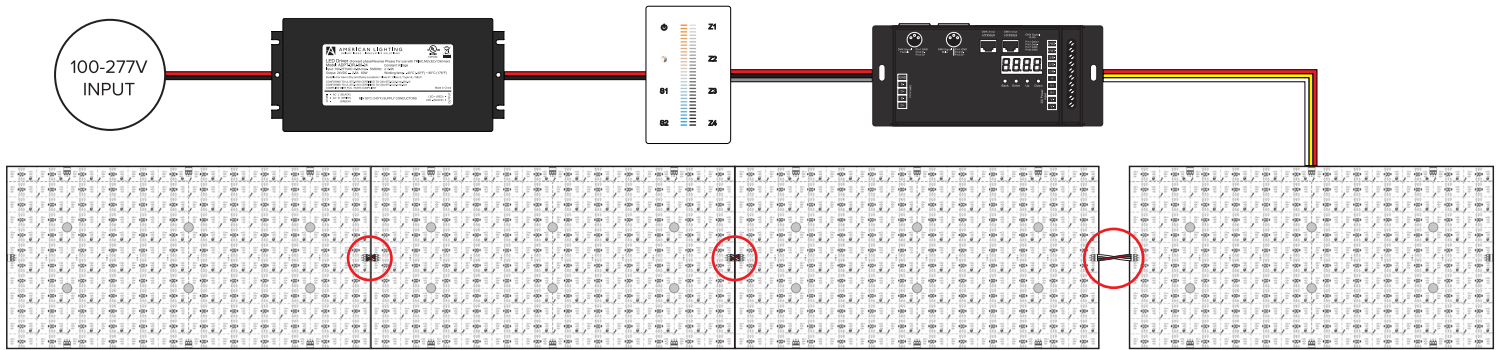

*** NOTE: When linking multiple Canvas sheets, wire polarity must be matched by crossing jumper wires ***

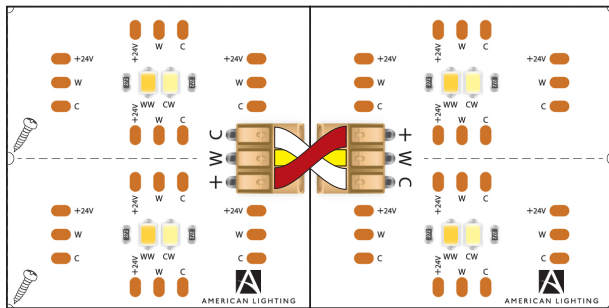

Example of Side by Side Linking

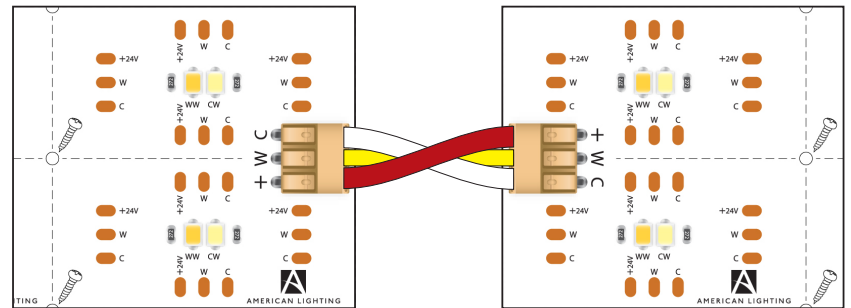

Example of Sheet to Sheet Jumper Linking

Recommended Wire Gauge: 20AWG (Solid Core)

RECOMMENDED POWER SUPPLIES

ITEM NUMBER	DESCRIPTION	MAX / MIN LOAD	INPUT VOLTAGE	OUTPUT VOLTAGE	DIMMABLE	DIMENSIONS
ADPT-DRJ-30-24	Adaptive Series 30W	30W / 3W	100-277V AC	24V DC	Yes*	6.49"L x 3.6"W x 1.02"H
ADPT-DRJ-60-24	Adaptive Series 60W	60W / 6W	100-277V AC	24V DC	Yes*	7.4"L x 3.6"W x 1.02"H
ADPT-DRJ-96-24	Adaptive Series 96W	96W / 9.6W	100-277V AC	24V DC	Yes*	8.66"L x 3.6"W x 1.61"H
ADPT-DRJ-192-24	Adaptive Series 192W (2 x 96W)	192W / 19.2W	100-277V AC	24V DC	Yes*	10.94"L x 4.25"W x 1.8"H
ADPT-DRJ-288-24	Adaptive Series 288W (3 x 96W)	288W / 28.8W	100-277V AC	24V DC	Yes*	11.85"L x 4.25"W x 1.8"H

Phase Dimming Compatible With Most MLV, ELV, and TRIAC Dimmers



AMERICAN LIGHTING WARRANTY

LIMITED WARRANTY FOR LED PRODUCTS: 5 YEARS

LIMITED PRODUCT WARRANTY

Our products are warranted to be free from defects in material and workmanship for the warranty period listed. Warranty periods begin from the date of shipment from American Lighting Inc's warehouse to the original purchaser. Products that prove to be defective during their specific warranty period will be either repaired or replaced, at the sole discretion of American Lighting Inc. Claims for defective products must be submitted in writing to American Lighting Inc's RGA Department within the warranty period. Upon approval of such return, American Lighting Inc reserves the right to inspect the product for misuse or abuse. Claims for indirect or consequential damages or for product that, in American Lighting Inc's opinion, has been misused will be denied. This is a warranty of product reliability only and not a warranty of merchantability or fitness for a particular purpose. American Lighting Inc shall have no liability whatsoever in any event for payment of incidental or consequential damages, including, without limitations, installation costs and/or damages for personal injury and/or property. These products may represent a possible shock or fire hazard if improperly installed or altered in any way. This warranty does not apply to any product that has not been properly installed in accordance with current local codes and/or the National Electrical Code. Products that require a transformer, driver, or power supply must be used in conjunction with American Lighting Inc's recommended power supply to ensure safety and retain product warranty.

PRODUCT SPECIFICATIONS

For the latest product information, updates, instructions and details concerning specifications, colors, finishes, performance, installation and design, visit www.americanlighting.com. Color may vary from the color printed herein due to limitations in photographic and printing processes. American Lighting Inc. reserves the right to change product specifications without notice. Other product specifications such as color temperature, wavelength characteristics and lumen output are subject to production limitations and may vary.

LED technology is changing rapidly, and not all color temperatures and performance levels can be duplicated at a later time. Best practices include purchasing 10-15% more for a particular project on the same initial order where white LED color temperatures must be maintained over project and product life. Eventual product replacement should be considered at layout and design stages. Best practices also include testing connections and product performance prior to mounting and/or installing.

AVERAGE LIFE

Average incandescent lamp life, rated life and average life are terms used to describe the number of hours at which half of the lamps have failed. For LEDs, the hours of rated life specify the point where 70% of original lumen output is reached. Below this point, the effective life is over, however, the LED may still emit light. Individual results may vary with actual environmental conditions including, but not limited to, proper installation, ambient temperature and/or input voltage fluctuations.