



Texas Fluorescents
Reinvented

CATALOG#: _____
PROJECT: _____
TYPE: _____

Series CPY

Economy LED Canopy

Parking structures, storage areas, shopping area walkways, entryway, and low level security

CONSTRUCTION

Polyester powder dark bronze finish. Multi-stage process produces 3 mil thickness for superior corrosion resistance and maximum durability. Precision die-cast aluminum housing with stainless steel fasteners.

MOUNTING

Three 1/2" threaded conduit and one 3/4" conduit entry points.
Surface mount only



DIMENSIONS

10" x 10"

FEATURES & BENEFITS

- Sealed die-casting profile for indoor and outdoor applications
- Rugged construction allows for use in punishing environments
- Suitable for use in -40°C to +40°C (-40°F to 104°F)
- Polycarbonate optical lens with heat resisting
- Three 1/2" threaded conduit and one 3/4" conduit entry points
- Multiple voltage input is available, support 120-277V
- Low profile design
- UL/cUL listed for wet locations
- Replacing 100-175MH
- Lumen output from 4100lm-6700lm



DRAWINGS & IMAGES

Side

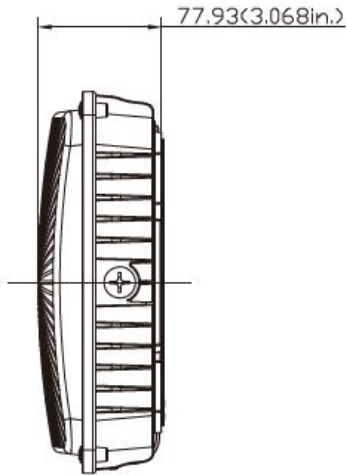

Top

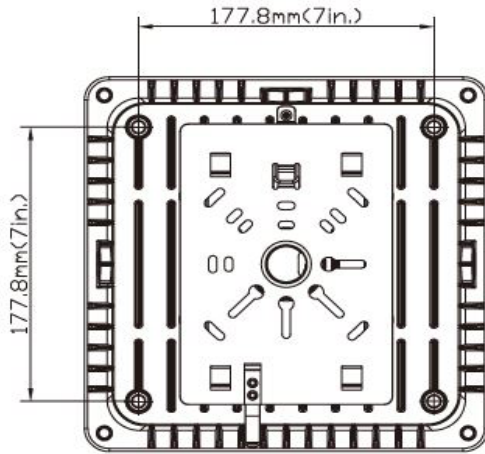

Bottom

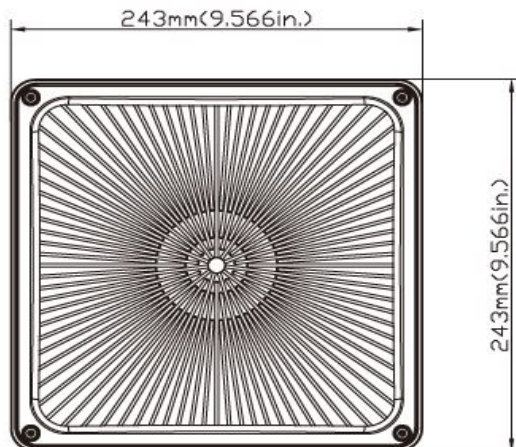

PHOTOMETRICS - TRANSPARENT LENS

CPY10L45W4200LDMV50K

Luminous Intensity Distribution Curve

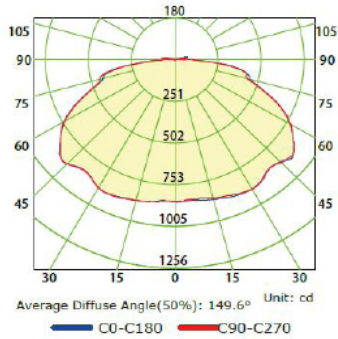

Illuminance at a Distance

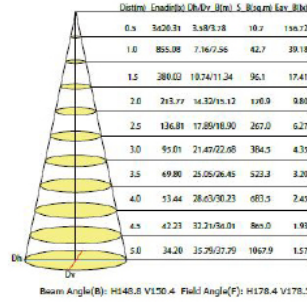

NOTE: Typical mounting height is 2.5-4.5 meters (8ft to 15ft)

CPY10L65W6600LDMV50K

Luminous Intensity Distribution Curve

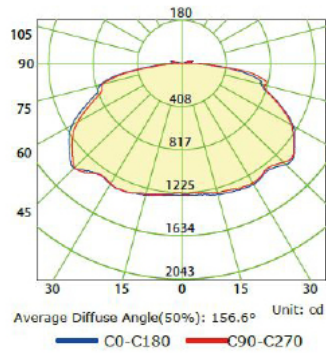

Illuminance at a Distance

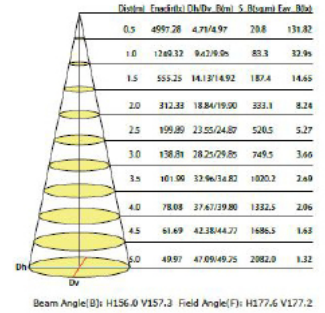

Average Diffuse Angle(50%): 156.6° Unit: cd
— C0-C180 — C90-C270

PRODUCT NUMBERS

SERIES	SIZE	WATTAGE & LUMENS	DRIVER	COLOR
CPY	10L 10" x 10"	45W4200L 45 Watts 4200 Lumens 65W6600L 65 Watts 6600 Lumens	DMV 0-10V Dimming 120V-277V	50K 5000K

DLC Listed Items

ITEM NUMBER
CPY10L45W4200LDMV50K
CPY10L65W6600LDMV50K



We reserve the right to change design, materials, LED's and finish in any way that will not alter installed appearance or reduce function and performance.