

Project Name:

Part Number:

Type:

DISCOVERY

LINEAR STRIP



407-478-3759
www.ilp-inc.com

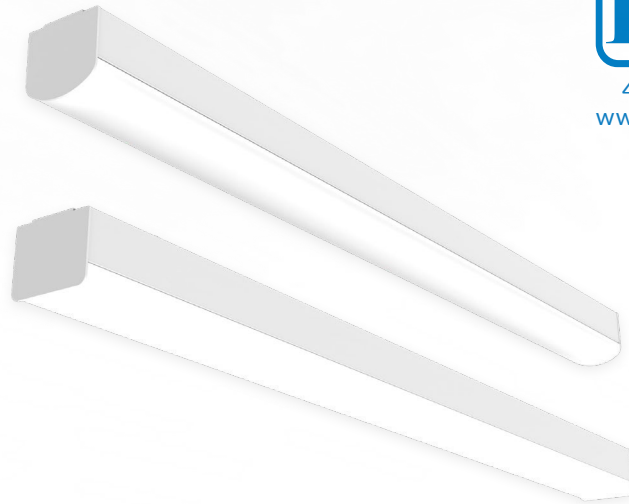

FEATURES

- Highly Configurable BAA Spec Grade Strip Luminaire
- Sleek injection-molded endcap design
 - Decorative No Knockout end cap option
- No visible fasteners providing a smooth uninterrupted design
- Precision Designed Low UGR Curved & Flat Frosted Acrylic Lens options
- High Performance Narrow or Wide Distribution Optics
- White (Std.) and optional Black, Silver, or Custom Finishes
- Sleek Integrated Wireless Grouping Control Options
- Surface, Cable, Suspension, Pendant, & Wall Mounting Options
- Asymmetrical & Symmetrical White Reflector Options
- 2ft, 4ft & 8ft Lengths available
- 18 Lumen Packages Ranging 2,000L – 20,000L
- Standard Efficacy (SE) and High Efficacy (HE) Lumen Packages
- 3000K, 3500K, 4000K, and 5000K CCT options available
- 80 or 90 CRI
- 120-277V & 347V 0-10V, Bi-Level & Line Voltage Driver Options
- 0-10V Dimmable Driver (100% -10%)
- L90>54,000 hrs
- -4°F to 122°F Ambient Temperature Range
- 5 Year Warranty (std); 10 Year Warranty Optional
- ETL Listed for Dry and Damp Locations



*Optional

SUITABLE APPLICATIONS

- Offices
- Education
- Storage Facility
- Garages
- Retail
- Warehouses
- Distribution Centers
- Grocery Stores
- Healthcare
- Hallways

ORDERING GUIDE:

SERIES	LUMENS	LIGHT ENGINE	DRIVER	80CRI/CCT	LENS OPTIONS	DISTRIBUTION	FINISH	END CAP	WARRANTY
DSC2 ¹	2L	SE ² Standard Efficacy	U 120-277V	50 5000K	FFLGR Frosted Flat	(BLANK) Wide	(BLANK) White	(BLANK) End Cap w/ Knockout	(BLANK) 5 Year
2' Discovery	3L	HE High Efficacy	HV 347V	40 4000K	Glare Reducing Lens	ND ⁴ Narrow	BLK ^{16,17} Black	NEKO End Cap w/o Knockout	10YR 10 Year
	4L			35 3500K	FCLGR Frosted Curved		SLV ^{16,17} Silver		
				30 3000K	Glare Reducing Lens		C ^{16,17} Custom		
DSC4 4' Discovery	2L								
	3L								
	4L			90CRI/CCT					
	6L			940 ⁹ 4000K					
	8L ¹			935 ¹ 3500K					
	10L ^{1,18}			930 ¹ 3000K					
DSC8 8' Discovery	5L								
	6L								
	8L								
	10L								
	12L								
	14L ¹								
	16L ^{1,18}								
	18L ^{1,18}								
	20L ^{1,18}								

¹ Only available with High Efficacy Option

² Adds 2in to Nominal Fixture Length. See Line Drawings for more detail

³ Adds 4in to Nominal Fixture Length. See Line Drawings for more detail

⁴ Option Ships without Lens

⁵ Contact Factory for Availability

⁶ Must be used with SR Sensor Ready Driver

⁷ Used only when mounting fixtures in continuous rows.
One needed between each fixture.

⁸ Mounted on End Cap of fixture.
Not compatible with NEKO option.

⁹ Not available with DSC2 models

¹⁰ Mounted Integral within Fixture Length

¹¹ Must be used w/ ES/PCD and ES/IR options for commissioning

¹² Must be used with HUB for single point mounting for 4ft models.

¹³ 8ft models must be dual point mounted.

¹⁴ One required per 4ft section

¹⁵ One needed per project

¹⁶ Must be used with ES/PCD

¹⁷ May reduce published performance; consult factory

¹⁷ May reduce max ambient; consult factory

¹⁸ Not available with 90CRI option

¹⁹ Operation down to 32°F

²⁰ Operation down to 14°F

²¹ Must be used with FMB

²² Not compatible with NEKO option.

Wired through end cap of fixture.

²³ Not compatible with RW/SW

²⁴ Not Compatible RS or RA Option

ORDERING GUIDE:

OPTIONS		CONTROLS	
Factory Installed		Basic - Factory Installed	
SR	Sensor Ready Driver	FIOS ^{2,10,20}	On/Off Occupancy Sensor
DR	DALI Ready Driver	FIOSPC ^{2,10}	On/Off Occupancy Sensor w/ Photocell
DIM1	1% Dimming Driver	FIOSPC/DLH ^{2,10}	On/Off Occupancy Sensor w/ Daylight Harvesting
BLD	Bi-Level Dimming Driver w/ Two Hot Leads (100%/50%)	DHPC ^{8,20,23}	Daylight Harvesting Photocell
LVD120	Mark X Phase Dimming 120V	USBD ^{3,10,23}	User Selectable Bi-Level Dimming Occupancy Sensor
Cx/yW	Cord (x=Length;6,10,15) (y=# of conductors; 3,4,5,6)	BDxx ^{3,10,23}	Preset Bi-Level Dimming Occupancy Sensor (xx=% eg. 20,30)
Cx/yW/L715P	Factory installed cord with a L715P plug attached (x=Length; 6,10) (y=# of conductors; 3,5)	BDxxPC ^{3,10,23}	Preset Bi-Level Dimming Occupancy Sensor (xx=% eg. 20,30) w/ Photocell
QDCx	Quick Disconnect Cord (x=ft)		
RW/3W ^{2,22}	3 Wire Raceway Wiring Harness for continuous wiring through fixture (non-dimming)		
RW/5W ^{2,22}	5 Wire Raceway Wiring Harness for continuous wiring through fixture (dimming)		
EM6 ^{9,19}	6W Factory Installed Battery Backup		
EM6/HE ¹⁹	6W Factory Installed Battery Backup - CEC Title 20 Compliant		
EM6/HE/SD ^{9,19}	6W Factory Installed Self Diagnostic Battery Backup - CEC Title 20 Compliant		
EM10 ^{9,19}	10W Factory Installed Battery Backup		
EM10/HE ^{9,19}	10W Factory Installed Battery Backup - CEC Title 20 Compliant		
EM10/HE/SD ^{9,19}	10W Factory Installed Battery Backup - Self Diagnostic		
EM12 ^{9,19}	12W Factory Installed Battery Backup		
GTD ⁹	Generator Transfer Device		
UL924 ⁹	UL 924 Emergency Device		
			Advanced - Factory Installed
		ES ^{2,10,15,23}	EasySense Grouping Sensor for Mounting Heights < 10ft
		ES/HB ^{8,11,23}	EasySense Grouping Sensor for Mounting Heights > 10ft
		5E/5W/CL ^{2,10,23}	Enlighted 5E Connected Lighting (CL) Sensor w/ Aux Driver / 5 Wire Connection
		5E/5W/IOT ^{2,10,23}	Enlighted 5E Internet of Things (IL) Sensor w/ Aux Driver / 5 Wire Connection
		VDO ^{2,6,10,23}	Lutron Vive DFCSJ-OEM-OCC (Daylight & Occupancy)
		VRF ^{2,6,10,23}	Lutron Vive DFCSJ-OEM-RF (RF Only)
		AWN ^{2,10,23}	Lutron Athena Wireless Node RF Only

Ship With Accessories	
WC ²⁴	11ga Unpainted Galvanized Finish Wire Cage
FMB ¹²	Fixture Mounting Box
HUB 3/4 ^{13,21}	Conduit Hub 3/4" for pendant mounting
ACxY	Y-Toggle Aircraft Cable System (x=ft)
VC	V-Clips for Mounting with Customer Supplied Chain
TGMB	T-Grid Mounting Bracket Set
WM45	45 Degree Angled Mounting Bracket Set
ALBR ⁷	Continuous Row Alignment Bracket
QMBR	Quick Surface Mounting Bracket Set
ES/PCD ¹⁴	EasySense Pre-Programmed Control Device
ES/IR ¹⁵	EasySense Commission IR Blaster
ES/WWS/DR	EasySense Dual Rocker Wireless Wall Switch
RS	Reflector Kit, Symmetrical, White
RA	Reflector Kit, Aymmetrical, White

¹ Only available with High Efficacy Option

² Adds 2in to Nominal Fixture Length. See Line Drawings for more detail

³ Adds 4in to Nominal Fixture Length. See Line Drawings for more detail

⁴ Option Ships without Lens

⁵ Contact Factory for Availability

⁶ Must be used with SR Sensor Ready Driver

⁷ Used only when mounting fixtures in continuous rows.

⁸ One needed between each fixture.

⁹ Mounted on End Cap of fixture.

¹⁰ Not compatible with NEKO option.

⁹ Not available with DSC2 models

¹⁰ Mounted Integral within Fixture Length

¹¹ Must be used w/ ES/PCD and ES/IR options for commissioning

¹² Must be used with HUB for single point mounting for 4ft models.
8ft models must be dual point mounted.

¹³ One required per 4ft section

¹⁴ One needed per project

¹⁵ Must be used with ES/PCD

¹⁶ May reduce published performance; consult factory

¹⁷ May reduce max ambient; consult factory

¹⁸ Not available with 90CRI option

¹⁹ Operation down to 32°F

²⁰ Operation down to 14°F

²¹ Must be used with FMB

²² Not compatible with NEKO option.

²³ Wired through end cap of fixture.

²³ Not compatible with RW/5W

²⁴ Not compatible with RS or RA

LED SYSTEMS INFO ¹		Light Engine	Lens	3000K		3500K		4000K		5000K		Wattage ²	Replaces	CRI	DLC Listing ³
Part Numbers				Lumens	lm/W	Lumens	lm/W	Lumens	lm/W	Lumens	lm/W				
DSC2-2L	HE	FFLGR	2255	143	2294	146	2332	148	2409	153	16	1T8	80	Standard	
		FCLGR	2282	145	2321	148	2360	150	2438	155				Standard	
DSC2-3L	HE	FFLGR	2949	151	3000	154	3050	156	3151	162	19	2T8	80	Standard	
		FCLGR	2984	153	3035	156	3086	158	3188	164				Standard	
DSC2-4L	HE	FFLGR	3852	147	3918	149	3983	152	4115	157	26	2T8	80	Standard	
		FCLGR	3897	149	3964	151	4031	154	4164	159				Standard	
DSC4-2L	HE	FFLGR	2602	159	2646	162	2691	164	2780	170	16	1T8	80	Premium	
		FCLGR	2633	161	2678	163	2723	166	2813	172				Standard	
	SE	FFLGR	2611	148	2652	151	2693	153	2775	158	18		80	Standard	
		FCLGR	2562	146	2602	148	2642	151	2723	155			Premium		
DSC4-3L	HE	FFLGR	3051	152	3103	155	3155	157	3260	162	20	2T8	80	Premium	
		FCLGR	3009	150	3060	153	3112	155	3215	160				Standard	
	SE	FFLGR	3143	140	3192	142	3242	144	3340	149	22		80	Standard	
		FCLGR	3112	138	3161	141	3210	143	3235	147			Premium		
DSC4-4L	HE	FFLGR	4533	149	4611	151	4689	154	4844	159	30	2T8	80	Premium	
		FCLGR	4587	151	4666	153	4744	156	4901	161				Premium	
	SE	FFLGR	4436	131	4506	133	4576	135	4715	139	34		80	Premium	
		FCLGR	4395	129	4464	131	4532	133	4670	138			Standard		
DSC4-6L	HE	FFLGR	6270	154	6377	156	6485	159	6699	164	41	3T8	80	Premium	
		FCLGR	6278	152	6385	155	6493	157	6708	162				Premium	
	SE	FFLGR	5985	143	6087	145	6190	147	6395	152	42		80	Premium	
		FCLGR	6056	144	6160	147	6263	149	6471	154			Premium		
DSC4-8L	HE	FFLGR	8953	150	9107	153	9260	155	9566	161	60	2T5HO	80	Premium	
		FCLGR	9060	152	9215	155	9370	157	9680	162				Premium	
DSC4-10L	HE	FFLGR	9776	136	9943	139	10111	141	10445	146	72	3T5HO	80	Premium	
		FCLGR	9836	137	10067	140	10236	143	10575	147				Premium	
DSC8-5L	HE	FFLGR	4891	156	4975	159	5058	162	5226	167	31	2T8	80	Premium	
		FCLGR	4949	158	5034	161	5118	164	5288	169				Premium	
	SE	FFLGR	5101	147	5181	149	5261	152	5421	156	35		80	Premium	
		FCLGR	5053	146	5132	148	5211	150	5370	155			Premium		
DSC8-6L	HE	FFLGR	6151	155	6257	158	6362	161	6572	166	40	4T8	80	Premium	
		FCLGR	6224	157	6331	160	6437	163	6650	168				Premium	
	SE	FFLGR	6412	142	6512	145	6613	147	6814	151	45		80	Premium	
		FCLGR	6351	141	6451	143	6550	145	6749	150			Premium		
DSC8-8L	HE	FFLGR	8879	149	9031	152	9183	154	9487	159	60	2T5HO	80	Premium	
		FCLGR	8985	151	9138	154	9292	156	9599	161				Premium	
	SE	FFLGR	8229	137	8358	139	8487	141	8745	146	60		80	Standard	
		FCLGR	8151	136	8279	138	8407	140	8662	144			Standard		
DSC8-10L	HE	FFLGR	10786	154	10971	157	11155	159	11524	164	70	2T5HO	80	Premium	
		FCLGR	10914	156	11101	158	11288	161	11661	166				Premium	
	SE	FFLGR	10104	141	10277	143	10450	146	10796	150	72		80	Premium	
		FCLGR	10225	142	10399	145	10574	147	10924	152			Premium		
DSC8-12L	HE	FFLGR	12205	148	12414	150	12623	153	13040	158	83	6T8	80	Premium	
		FCLGR	12350	150	12561	152	12773	155	13195	160				Premium	
	SE	FFLGR	12915	136	13136	138	13357	140	13799	145	95		80	Premium	
		FCLGR	13069	137	13292	140	13516	142	13963	147			Premium		
DSC8-14L	HE	FFLGR	13112	144	13336	146	13561	149	14009	154	91	6T8	80	Premium	
		FCLGR	13268	146	13495	148	13722	151	14176	156				Premium	
DSC8-16L	HE	FFLGR	14993	142	15250	145	15506	147	16019	152	105	4T5HO	80	Premium	
		FCLGR	15171	144	15431	146	15691	149	16210	154				Premium	
DSC8-18L	HE	FFLGR	16733	140	17019	142	17305	145	17878	149	120	4T5HO	80	Premium	
		FCLGR	16932	142	17221	144	17511	146	18090	151				Premium	
DSC8-20L	HE	FFLGR	19635	137	19971	139	20307	142	20979	146	143	6T5HO	80	Premium	
		FCLGR	19868	139	20208	141	20548	143	21228	148				Premium	

¹ Values are nominal, check IES file for more detail

² Electrical data at 25C (77F). Actual wattage may differ by +/-10%.

³ All SKUs may not be DLC listed, check QPL

ELECTRICAL DATA (AMPS)

Lumen Package	Wattage	120V	208V	240V	277V	347V	480V
DSC2-2LHE	15.7	0.13	0.08	0.07	0.06	0.05	0.03
DSC2-3LHE	19.5	0.16	0.09	0.08	0.07	0.06	0.04
DSC2-4LHE	26.2	0.22	0.13	0.11	0.09	0.08	0.05
DSC4-2LHE	16.4	0.14	0.08	0.07	0.06	0.05	0.03
DSC4-2LSE	17.6	0.15	0.08	0.07	0.06	0.05	0.04
DSC4-3LHE	20.1	0.17	0.10	0.08	0.07	0.06	0.04
DSC4-3LSE	22.0	0.18	0.11	0.09	0.08	0.06	0.05
DSC4-4LHE	30.4	0.25	0.15	0.13	0.11	0.09	0.06
DSC4-4LSE	34.0	0.28	0.16	0.14	0.12	0.10	0.07
DSC4-6LHE	40.8	0.34	0.20	0.17	0.15	0.12	0.09
DSC4-6LSE	42.0	0.35	0.20	0.17	0.15	0.12	0.09
DSC4-8LHE	59.6	0.50	0.29	0.25	0.22	0.17	0.12
DSC4-10LHE	71.8	0.60	0.35	0.30	0.26	0.21	0.15
DSC8-5LHE	31.3	0.26	0.15	0.13	0.11	0.09	0.07
DSC8-5LSE	34.7	0.29	0.17	0.14	0.13	0.10	0.07
DSC8-6LHE	39.6	0.33	0.19	0.17	0.14	0.11	0.08
DSC8-6LSE	45.1	0.38	0.22	0.19	0.16	0.13	0.09
DSC8-8LHE	59.5	0.50	0.29	0.25	0.21	0.17	0.12
DSC8-8LSE	60.1	0.50	0.29	0.25	0.22	0.17	0.13
DSC8-10LHE	70.1	0.58	0.34	0.29	0.25	0.20	0.15
DSC8-10LSE	71.8	0.60	0.35	0.30	0.26	0.21	0.15
DSC8-12LHE	82.5	0.69	0.40	0.34	0.30	0.24	0.17
DSC8-12LSE	95.2	0.79	0.46	0.40	0.34	0.27	0.20
DSC8-14LHE	91.1	0.76	0.44	0.38	0.33	0.26	0.19
DSC8-16LHE	105.5	0.88	0.51	0.44	0.38	0.30	0.22
DSC8-18LHE	119.6	1.00	0.58	0.50	0.43	0.34	0.25
DSC8-20LHE	143.5	1.20	0.69	0.60	0.52	0.41	0.30

¹ Electrical data at 25C (77F). Actual wattage may differ by +/-10%

AMBIENT TEMPERATURE RANGE

Part Number	Suspended	Surface
DSC2-2LHE	113	104
DSC2-3LHE	113	104
DSC2-4LHE	113	104
DSC4-2LHE	113	104
DSC4-3LHE	113	104
DSC4-4LHE	113	104
DSC4-6LHE	104	95
DSC4-8LHE	113	104
DSC4-10LHE	104	95
DSC8-5LHE	113	104
DSC8-6LHE	104	95
DSC8-8LHE	113	104
DSC8-10LHE	104	95
DSC8-12LHE	104	95
DSC8-14LHE	122	113
DSC8-16LHE	113	104
DSC8-18LHE	95	86
DSC8-20LHE	104	95
DSC4-2LSE	113	104
DSC4-3LSE	113	104
DSC4-4LSE	113	104
DSC4-6LSE	104	95
DSC8-5LSE	104	95
DSC8-6LSE	131	122
DSC8-8LSE	113	104
DSC8-10LSE	104	95
DSC8-12LSE	113	104

SPECIFICATIONS

CONSTRUCTION

Steel housing body for rigidity, durability, and ease of installation. Designed to achieve maximum performance and improved aesthetics. Injection molded end caps provide sleek and robust design. End caps available with knockouts or No End Cap Knockout Options (NEKO). Power access plate mounted on back of fixture for easy access to wiring in addition to various knockouts along back of fixture. Product proudly assembled in the United States of America.

ELECTRICAL

Class 2 LED light engine for high efficacy and long life. Calculated L70 > 100,000 hrs and L90 > 54,000hrs. LED Lumen Maintenance Estimates based on TM-21 projections for the light source at 25°C ambient. Power Factor > 0.90. THD < 20%. Standard 120-277 Vac 0-10V dimmable (10%-100%) with optional 347 Vac High Voltage, Bi-Level, 1% Dimming, and 120V Line Voltage Dimming Options. Optional emergency battery backups, generator transfer device, and UL924 devices available to meet critical life safety lighting requirements.

INSTALLATION

Designed for a variety of mounting solutions including ceiling, wall, pendant and suspended. Fixtures can be mounted in continuous rows with appropriate hardware and wiring options. Knockouts mounted on back and end of fixture for electrical access and mounting.

CONTROLS OPTIONS

BASIC

FIOS

Standard on/off motion sensor. Comes with 360 degree high bay lens, 360 degree low bay lens & aisle lens. 360 degree high bay lens factory installed, unless notified otherwise.

FIOSPC

Motion sensor with the addition of photocell control. When installed, fixture will not activate unless 1. motion is detected and 2. light levels are below the preset level. When activated, fixture will turn on to 100% light output & will only shut off when one of the two levels mentioned above are met. If no motion is detected & light levels fall below preset level the fixture remains off.

FIOSPC/DLH

Factory installed motion sensor with the addition of photocell control that will allow for daylight harvesting. When installed, fixture will not activate unless 1. motion is detected & 2. light levels are below the preset level. When activated, fixture will turn on only enough to meet the preset light levels and will adjust as the amount of light in the space adjusts between 100%-10%. If light levels are adequate the fixture will remain off.

DHPC

Daylight Harvesting off photocell. Fixtures will continually dim up/down throughout the day based on light level readings taken from the photocell control.

OPTICS

High impact resistant Curved and Flat Frosted Glare Reducing Acrylic lens available for durability and LED Glare reduction. Standard wide and optional narrow distribution optics available. Field removable lens section for easy access to driver channel for installation and maintenance.

CONTROLS

Factory installed Advanced and Basic sensor options available to maximize energy savings. Please see more information below on Pages 5 & 6. Inquire with manufacturer for additional controls options, including customer supplied items.

CERTIFICATIONS

ETL Listed to US and Canadian safety standards. Suitable for damp locations. Title 24 Compliant with sensor option; see local ordinance for qualification information. DLC (DesignLights Consortium) Premium Qualified. Please refer to the DLC Qualified Products List at www.Designlights.org/QPL to confirm specific product qualifications.

WARRANTY

5 Year Warranty Standard; 10 Year Warranty Optional ([Terms and Conditions](#) apply).

USB

User Selectable Bi-Level Dimming. Allows the end user to manually select the unoccupied dimming level. Once motion is detected, the fixture will return to 100% light output.

BDxx

Factory set Bi-Level Dimming. Sensor is set to dim level, as indicated in the "xx" portion of the part number, when the area is unoccupied. Example: BD20 sets the fixture to dim down to 20% lumen output when the area is unoccupied. Once motion is detected, the fixture will return to 100% light output.

BDxxPC

Factory set Bi-Level Dimming with motion and photocell. Sensor is set to dim level, as indicated in the "xx" portion of the part number, when the area is unoccupied and will not return to 100% light output unless 1. motion is detected and 2. the light level is below the preset level. Example: BD20PC sets the fixture to dim down to 20% lumen output when the area is unoccupied and will not return to 100% light output unless the above conditions are met for both motion and light level readings.

ADVANCED

EASYSENSE

ES

EasySense sensor combines occupancy sensing, daylight harvesting & institutional tuning in one compact solution. This is an ideal control for any commercial application. Each sensor allows you to turn on/off occupancy and/or daylight harvesting functions as well as set the full light output, background light level, occupancy prolong time, occupancy grace fading time and occupancy time out/hold time. Requires the use of EasySense Pre-Programmed Control Device (ES/PCD), or approved phone from compatibility list; one needed per project.



ES/HB

EasySense Grouping Sensor for Mounting Heights > 10ft. Combines occupancy sensing, daylight harvesting & institutional tuning in one compact solution. This is an ideal control for any commercial application. Each sensor allows you to turn on/off occupancy and/or daylight harvesting functions as well as set the full light output, background light level, occupancy prolong time, occupancy grace fading time and occupancy timeout/hold time. Requires use of EasySense Pre-Programmed Control Device (ES/PCD) & Commissioning IR Blaster (ES/IR); one of each needed per project. (Sold separately).

ES/PCD

Pre-Programmed EasySense Control Device. One needed per project. Sensor can also be programmed with the approved compatible cell phone (listed below).

Compatible Cell Phones:

- LG G4
- Samsung S5
- Samsung Note 4
- Samsung S4 Mini
- Samsung S6
- Samsung Note Edge 1
- Samsung S4

ES/WWS/DR

Optional Wireless / Batteryless Dual Rocker Wall Switch. Up to 100ft range. Functions include: On/Off, dimming and setting of (2) scenes for full room control.

Specifications:

- Wireless
- ZigBee®
- Batteryless
- 30-100ft Range
- Dual Rocker



Functions:

1. On (Hold to brighten up)
2. Off (Hold to dim down)
3. Scene 1
4. Scene 2

ENLIGHTED

5E/5W/CL

Bundled System with Enlighted 5E sensor (SU-5E-CL), Control Unit (CU-4E-FM) and Cable (CBL-5E-CU4-30N). Fixtures are controlled based on occupancy and ambient light. Includes individual lighting control plus connection to Enlighted Energy Manager. The Energy Manager provides data analysis for all data collected by the Enlighted Smart Sensors for energy, occupancy and environment. Provided with factory installed components only. Enlighted system provided by others. Contact factory for more information. (see image above)

5E/5W/IOT

Bundled System with Enlighted 5E sensor (SU-5E-IOT), Control Unit (CU-4E-FM) and Cable (CBL-5E-CU4-30N). Fixtures are controlled based on occupancy and ambient light. Includes individual lighting control plus connection to Enlighted Energy Manager. Energy Manager provides data analysis for all data collected by Enlighted Smart Sensors for energy, occupancy & environment. Additionally, the IOT functionality takes the data access and function beyond just lighting to a wide range of applications beyond the standard connected lighting controls. Provided with factory installed components only. Enlighted system provided by others. Contact factory for more information. (see image above)

LUTRON

VDO

Vive DFCSJ-OEM-OCC integral fixture control sensor with daylight & occupancy. Vive provides intuitive programming allowing for maximum flexibility with wireless communication & sensing as desired. Provided with factory installed components only. Lutron system provided by others. Sensor must be used in conjunction with Pico Switch/Dimmer. Cannot be used in conjunction with mechanical on/off power switch. Contact factory for more information



VRF

Vive DFCSJ-OEM-RF integral fixture control with Radio Frequency (RF) communication. Vive provides intuitive programming allowing for maximum flexibility with wireless communication as desired. Providing with factory installed components only. Lutron system provided by others. Sensor must be used in conjunction with Pico Switch/Dimmer. Cannot be used in conjunction with mechanical on/off power switch. Contact factory for more information.



ANWR

Athena wireless node is a radio frequency (RF) device that enables simple, digital control of individual light fixtures in an Athena control system. Enables individual wireless control of each fixture in an Athena control system. Accommodates zone and control changes without rewiring. All drivers on the link are controlled as a single zone. Provided with factory installed components only. Lutron Athena system provided by others.



LINE DRAWINGS A - Knockout Locations

DSC 8: 96.2"

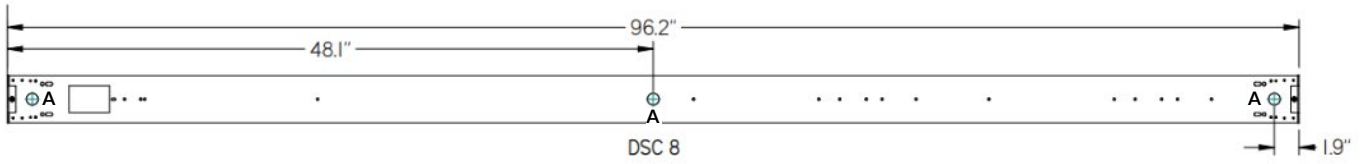

DSC 4: 48.2"

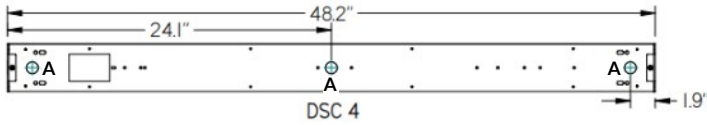

DSC 2: 24.2"

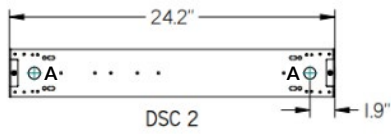

DSC2: 26.2" / DSC4: 50.2" / DSC8: 98.2"

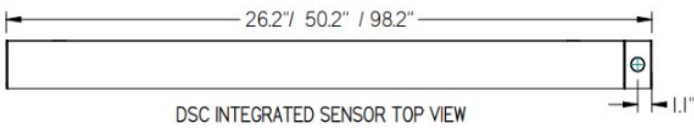

DSC2: 28.3" / DSC4: 52.3" / DSC8: 100.3"

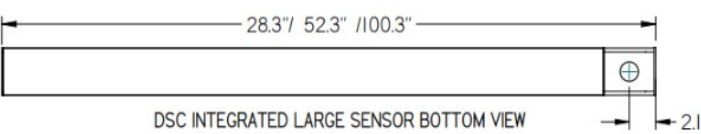

DSC - End Caps

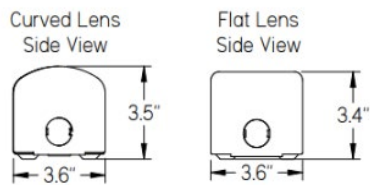

DSC 4: 48.2" - With RA Reflector Option



End Cap View

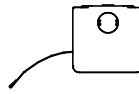

3/4 Angle View

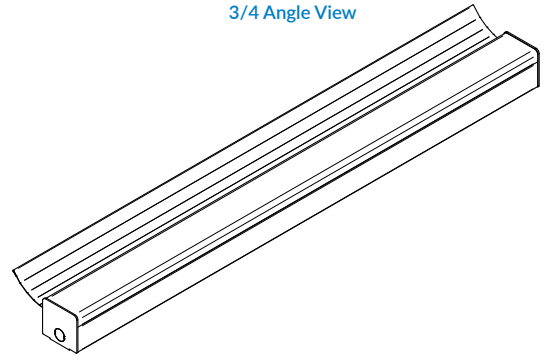

DSC 4: 48.2" - With RS Reflector Option

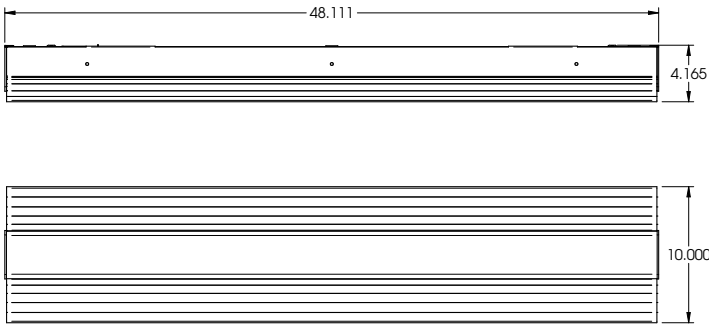

End Cap View

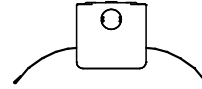

3/4 Angle View

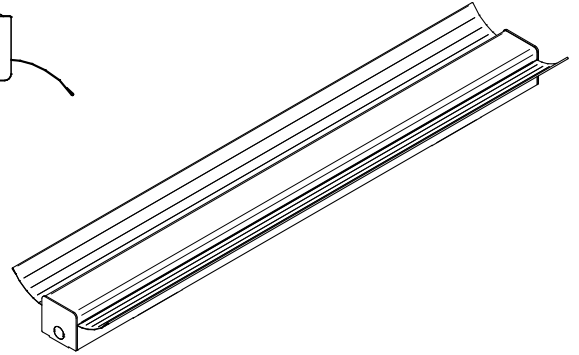

DSC 4 Curved Lens: 48.2" - With Wire Cage Option

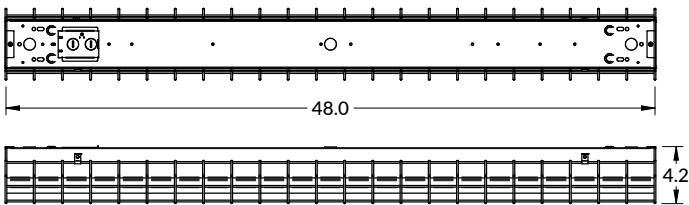

End Cap View

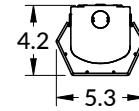

3/4 Angle View

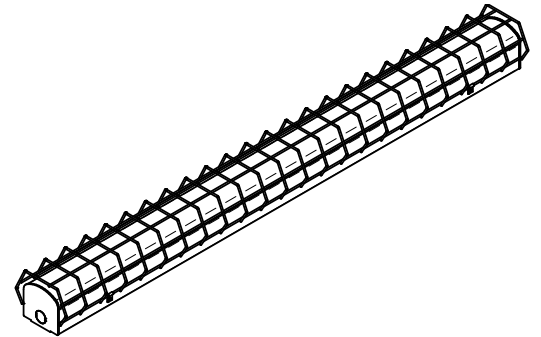

DSC 4 Flat Lens: 48.2" - With Wire Cage Option

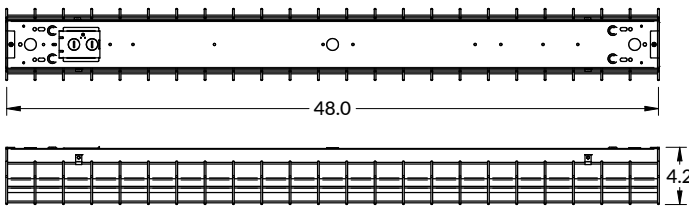

End Cap View

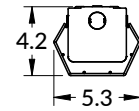

3/4 Angle View

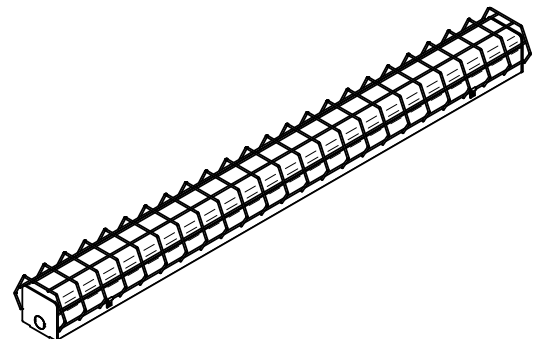

LINEAR STRIP PHOTOMETRICS

LUMINAIRE DATA	
Part Number	DSC2-4LHE-U-40-FFLGR
Description	2ft Linear Strip, High Efficiency, 4,000 Lumens, 4000K, Frosted Flat Glare Reducing Lens
Fixture Lumens (lm)	3983 Lumens
Wattage (W)	26 W
Efficacy (lm/W)	149 lm/W
Mounting	Surface
Spacing Criteria	0° = 1.28, 90° = 1.18

ZONAL LUMEN SUMMARY		
Zone	Lumens (lm)	% Fixture
0° - 40°	1809	45%
0° - 60°	3015	78%
0° - 90°	3734	99%
90° - 180°	249	1%
0° - 180°	3983	100%

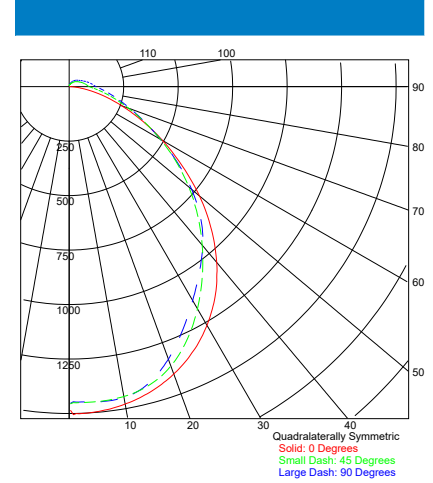

LUMINAIRE DATA	
Part Number	DSC4-10LHE-U-40-FFLGR
Description	4ft Linear Strip, High Efficiency, 10,000 Lumens, 4000K, Frosted Flat Glare Reducing Lens
Fixture Lumens (lm)	10111 Lumens
Wattage (W)	72 W
Efficacy (lm/W)	141 lm/W
Mounting	Surface
Spacing Criteria	0° = 1.28, 90° = 1.18

ZONAL LUMEN SUMMARY		
Zone	Lumens (lm)	% Fixture
0° - 40°	4592	45%
0° - 60°	7653	78%
0° - 90°	9479	99%
90° - 180°	632	1%
0° - 180°	10111	100%

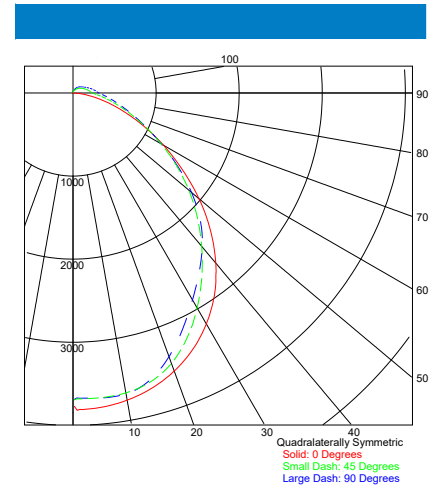

LUMINAIRE DATA	
Part Number	DSC8-20LHE-U-40-FFLGR
Description	8ft Linear Strip, High Efficiency, 20,000 Lumens, 4000K, Frosted Flat Glare Reducing Lens
Fixture Lumens (lm)	20307 Lumens
Wattage (W)	143 W
Efficacy (lm/W)	142 lm/W
Mounting	Surface
Spacing Criteria	0° = 1.28, 90° = 1.18

ZONAL LUMEN SUMMARY		
Zone	Lumens (lm)	% Fixture
0° - 40°	9223	45%
0° - 60°	15371	78%
0° - 90°	19037	99%
90° - 180°	1269	1%
0° - 180°	20307	100%

