



H-QSN15117 Warehouse Shade Collection

Job Name:	_____
Type:	_____
Quantity:	_____

**HI-LITE MFG.
CO., INC**

13450 Monte Vista Avenue
Chino, California 91710
Telephone: (909) 465-1999
Toll Free: (800) 465-0211
Fax: (909) 465-0907
web: www.hilitemfg.com
e-mail: sales@hilitemfg.com

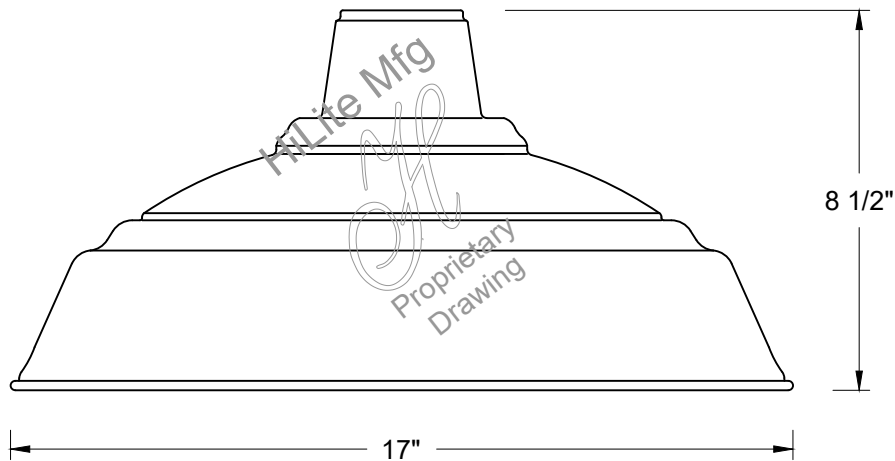

FINISH -Multi-stage pretreatment procedure using materials of polyester/polished powder coat, baking enamel liquid, raw metals, and galvanized finishes.

Finishes are: 91 (Black), 93 (White), 96 (Galvanized), 145 (Oil Rubbed Bronze)

All shades to be painted white inside except 96-Galvanized.

MOUNTING - Cord: C (8' Black Cord & Canopy)

Stem: H-QSN12"ST3, H-QSN24"ST3, H-QSN36"ST3

Arm: H-QSNB-13, H-QSNB-42, H-QSNB-44,

H-QSNHL-A, H-QSNHL-C, H-QSNHL-H

REFLECTOR - Heavy duty, spun shade, aluminum 6061-0 construction

CANOPIES (Available for stem mount only) - H-QSNHDSMC, H-QSNHSC

ACCESSORIES- H-QSNWGR-17", H-QSNSK

SOCKETS/LAMPS - Available in: Incandescent
-rated 200-watt max/120-volt, medium base

MADE IN THE U.S.A.

UL Wet (Arm)
UL Damp (Stem)
UL Dry (Cord)

