

JOB NAME:
CAT#:
TYPE:

APPLICATIONS

High efficiency LED engineered for premium performance in medium and high ceiling applications ideally suited for warehouses, manufacturing plants, sports facilities and retail spaces. A precision-formed reflector system available in highly reflective enhanced white reflector achieve maximum light output for ceilings from 15 feet to 40 feet. The unique arrangement is ideal for wide area lighting to put the light exactly where you need it with less fixtures. Based on ceiling height, these fixtures can replace an HID high bay using half of the wattage.

Housing is 22 gauge prepainted steel. Air vents surround the drivers in the back of the fixture to maximize LED and driver performance, reliability and life. High reflective enhanced white reflectors are computer designed to maximize photometric performance and put the light where you need it. Access plate in the back makes wiring fast and hassle-free. Back of fixture is designed with built-in mounting holes for cable kit. Mounting minimum is 18" from ceiling.



FEATURES & BENEFITS

- Designed for surface, pendant, stem or chain hanging
- Mounting holes provided for simple, fast installation
- Min CRI 80
- cETL_{US} Listed

DIMENSIONS

SIZE: W x L x H in inches

24L: 15.575W x 23.379"L x 4.296"H

48L: 15.575W x 45.160"L x 4.296"H

24L

TOP VIEW WITHOUT LENS

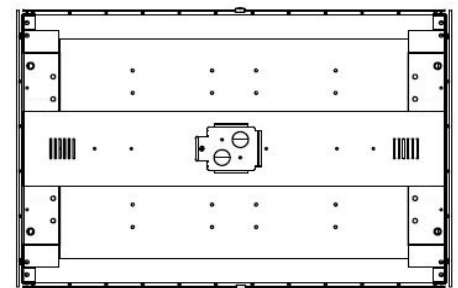
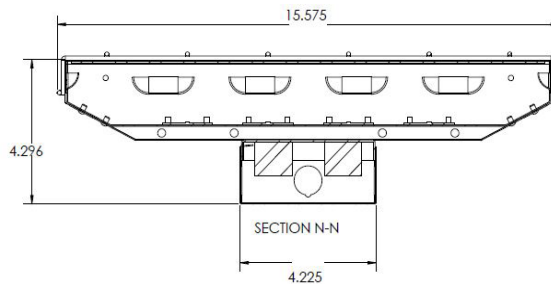
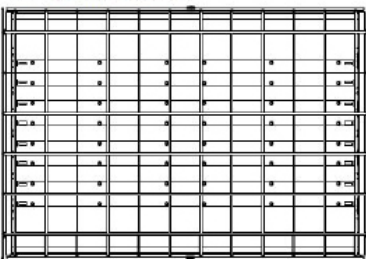

BOTTOM VIEW

Dimensions and specifications subject to change without notice.





JOB NAME:

CAT#:

TYPE:

DIMENSIONS

48L

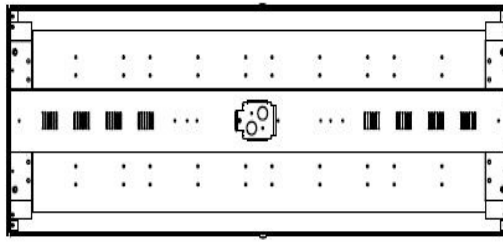
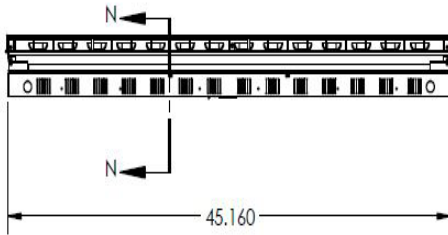
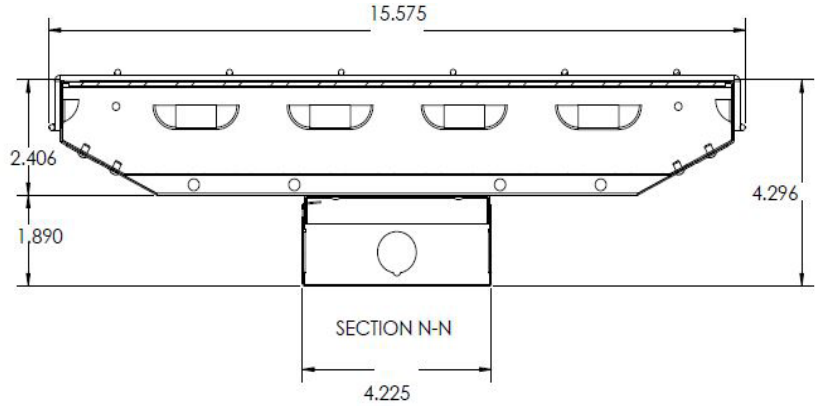
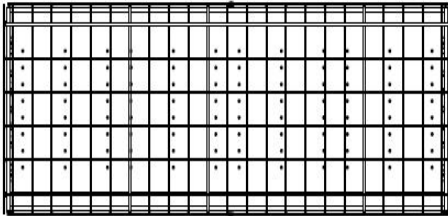

Bottom View

DLC INFORMATION

DLC Listed Fixtures		
Model Number	Color Temp	Options
HBPA48-LED175DMVxx	xx= 30,35,40,50	OS, OSD, WPx, EM, CSxx
HBPA48-LED215DMVxx	xx= 30,35,40,50	OS, OSD, WPx, EM, CSxx
HBPA48-LED220DMVxx	xx= 30,35,40,50	OS, OSD, WPx, EM, CSxx
HBPA48-LED260DMVxx	xx= 30,35,40,50	OS, OSD, WPx, EM, CSxx
HBPA48-LED280DMVxx	xx= 30,35,40,50	OS, OSD, WPx, EM, CSxx
HBPA48-LED315DMVxx	xx= 30,35,40,50	OS, OSD, WPx, EM, CSxx
HBPA48-LED355DMVxx	xx= 30,35,40,50	OS, OSD, WPx, EM, CSxx



Dimensions and specifications subject to change without notice.



JOB NAME:
CAT#:
TYPE:
ORDERING

EXAMPLE: HBPA 24 LED 80 DMV 30 EM OS CS8 WG

HBPA		LED					
1. SERIES	2. LENGTH	3. GEAR	4. LED MODULE DISTRIBUTION	5. WATTAGE/LUMENS	6. DRIVER	7. LENS	
HBPA	24 23.379"	LED	(Blank) Downlight Only	24	DMV 0-10V Dimming 120-277VAC Multivolt	Blank No Lens	FR Frosted
	48 45.160"		UM Additional 45W Uplight Module 5500 Lumens	80 80 Watts 10000 Lumens			
				122 122 Watts 15000 Lumens			
				175 175 Watts 21525 Lumens			
				48			
				80 80 Watts 10000 Lumens			
				122 122 Watts 15000 Lumens			
				149 149 Watts 21150 Lumens			
				175 175 Watts 25050 Lumens			
				186 186 Watts 26350 Lumens			
				215 215 Watts 31380 Lumens			
				220 220 Watts 33000 Lumens			
				260 260 Watts 36780 Lumens			
				273 273 Watts 38230 Lumens			
				280 280 Watts 41120 Lumens			
				315 315 Watts 45440 Lumens			
				355 355 Watts 50110 Lumens			

8. COLOR TEMP	9. EMERGENCY(O) ¹	10. SENSOR(O) ¹	11. CORD(O) ¹	12. WIRE GUARD(O) ¹
30 3000K	EM 10 Watt 1300 Lumen Battery Backup	OS Occ Sensor -On/Off OSD Occ Sensor w/ Dimming & Daylight Harvesting	CS8 8' cord, no plug CS12 12' cord, no plug	WG Wraparound Wireguard WP 6 ft. 3 wire, MC whip WP12 12 ft. 3 wire, MC whip
35 3500K				
40 4000K				
50 5000K				

*Cord & Whip Ordering Chart (Add to End of Fixture Part Number)						
Part No.	# of Wires	Length	End Fitting	Finish	Voltage	Amps (TL Only)
WP - Whip CS - Cordset	(Blank) 3 Wire 4 - 4 Wire 5 - 5 Wire 6 - 6 Wire	(Blank) 6 feet 8 - 8 feet 10 - 10 feet 12 - 12 feet 15 - 15 feet	(Blank) No Plug P* - Standard Plug TL* - Twist Lock	BK - Black WH - White	(Blank) 120-277V* 120 - 120V 277 - 277V 347 - 347V 480 - 480V	15 - 15 Amps 20 - 20 Amps

ACCESSORIES

A-HBPA24WG	Wireguard for HBPA24
A-HBPA48WG	Wireguard for HBPA48
A-AC120-TOGGLE-2PK	Yhook 10' cable mounting kit & 2 spring clips
A-AC180-TOGGLE-2PK	Yhook 15' cable mounting kit & 2 spring clips

NOTES:
¹(O) is optional

Dimensions and specifications subject to change without notice.

