

Project Name:

Part Number:

Type:



# HZV

## HAZARDOUS LOCATION LINEAR VAPOR TIGHT



407-478-3759  
www.ilp-inc.com

### FEATURES

- Robust Hazardous Location Narrow Body Linear Vapor Tight
- Class 1 Div 2 Groups A, B, C & D
- Class 1 Zone 2 Groups IIA, IIB+ H2, IIC
- UL844 Hazardous
- Industry Leading Max Ambient up to 131°F
  - Ambient Range -40°F to 131°F (Select Models)
- Extremely High Efficacy up to 156 lm/W
- 2ft, 4ft & 8ft Fixture Lengths
- Lumen Packages Ranging 2,000-24,000
- Surface, Pendant, Wall & Suspended Mounting Options
- Multiple Impact Resistant Lens Options
- Fiberglass Body Attributes:
  - T4 Housing Ignition Temperature Rated
  - F1 Weatherability Rating, 5VA Flame Rating & 1500 PSI High Pressure Hosedown
  - IP65, IP66 & IP67, NEMA4X, NSF
- 3000K-5000K CCT
- >80 Color Rendering Index (CRI)
- Calculated L70 >100,000 Hours
- 0-10V Dimmable Driver (100%-10%)
- 5 Year Warranty
- ETL Listed for Wet Location
- DesignLights Consortium® Premium Qualified Luminaire



HZ Series Playlist



SCAN ME  
or Click Here

**ASSOCIATED PRODUCTS**  
**HZB Hazardous High Bay**

**CLASS 1 DIV 2**  
GROUPS A, B, C, D

**NEMA4X**



### SUITABLE APPLICATIONS

- Chemical Processing Facilities
- Ethanol & Petroleum Refineries
- Industrial & Manufacturing Facilities
- Power Generation Facilities
- Wastewater & Water Treatment Facilities
- Food & Beverage Preparation
- Coolers & Freezers
- Natatorium <sup>10</sup>

### ORDERING GUIDE:

SERIES	LUMENS (select one)				DRIVER		CCT	LENS	
	2L	3L	4L	6L	U	HV		RAFL	SAFL
HZV2 2ft Hazardous Vapor Tight						120-277V	50	SAFL	Ribbed Acrylic Frosted (Std)
						347V-480V	40	SAFL	Smooth Acrylic Frosted
							35	SAFL	Smooth Acrylic Clear
HZV4 4ft Hazardous Vapor Tight							30	SPFL	Smooth Polycarbonate Frosted
								SPFL	Smooth Polycarbonate Clear
								SPCL	Smooth Polycarbonate Clear
								SPCL	Smooth Polycarbonate Clear
HZV8 8ft Hazardous Vapor Tight									

OPTIONS		MOUNTING OPTIONS	
Factory Installed			
SS	Stainless Steel Latches	ACXY	Adjustable Y-Toggle aircraft cable set (x = 5' or 10')
TPS	Tamper Proof Screws	HZ-HUB 3/4 <sup>4,5,7,8</sup>	Conduit Hub 3/4" for Pendant Mounting
EM10 <sup>1,2</sup>	10W Factory Installed Battery Backup	FMB <sup>5,6,7,8</sup>	Fixture Mounting Box for Pendant Mounting
Cx/3W <sup>9</sup>	3-wire cord standard fixtures (xFT = Length; x=6,10,15,20)	AB/45DEG/SS-HZV	45 Degree Stainless Steel Angled Mounting Bracket Set
Cx/5W <sup>9</sup>	5-wire cord for with external dim control (xFT = Length; x=6,10,15,20)		
EMH1	1/2" HUB installed in one end of housing for power entry		
EMH2 <sup>3</sup>	1/2" HUB installed in both ends of housing for power entry		

<sup>1</sup>Cannot be combined with the HV option

<sup>2</sup>Cannot be used with power cord

<sup>3</sup>One required per 4ft section

<sup>4</sup>Consult factory for use on HZV2

<sup>5</sup>Operating temp down to 32°F

<sup>6</sup>Must use with FMB for pendant mounting

<sup>7</sup>Not available for pendant mounting in Canada

<sup>8</sup>Not available with Plug; consult factory for demo model with plug

<sup>9</sup>Not available for pendant mounting in Canada

<sup>10</sup>When used with PC Lens and SS Latches

# HZV

## HAZARDOUS LOCATION LINEAR VAPOR TIGHT

SYSTEMS INFO <sup>1</sup>	3000K		3500K		4000K		5000K		Watts <sup>2</sup>	CRI	Replaces
Part Numbers	Lumens	Efficacy	Lumens	Efficacy	Lumens	Efficacy	Lumens	Efficacy			
HZV2-2L-U-XX-RAFL	2,355 lm	125 lm/W	2,431 lm	129 lm/W	2,532 lm	135 lm/W	2,532 lm	135 lm/W	19W	>80	1T8
HZV2-2L-U-XX-SAFL	2,316 lm	123 lm/W	2,391 lm	127 lm/W	2,490 lm	132 lm/W	2,490 lm	132 lm/W			
HZV2-2L-U-XX-SACL	2,511 lm	133 lm/W	2,592 lm	138 lm/W	2,700 lm	143 lm/W	2,700 lm	143 lm/W			
HZV2-2L-U-XX-SPFL	2,143 lm	114 lm/W	2,583 lm	137 lm/W	2,305 lm	122 lm/W	2,305 lm	122 lm/W			
HZV2-2L-U-XX-SACL	2,502 lm	133 lm/W	2,583 lm	137 lm/W	2,691 lm	143 lm/W	2,691 lm	143 lm/W			
HZV2-3L-U-XX-RAFL	3,053 lm	124 lm/W	3,152 lm	128 lm/W	3,283 lm	133 lm/W	3,283 lm	133 lm/W	25W	>80	1T8
HZV2-3L-U-XX-SAFL	3,003 lm	122 lm/W	3,100 lm	126 lm/W	3,229 lm	131 lm/W	3,229 lm	131 lm/W			
HZV2-3L-U-XX-SACL	3,256 lm	132 lm/W	3,361 lm	136 lm/W	3,501 lm	142 lm/W	3,501 lm	142 lm/W			
HZV2-3L-U-XX-SPFL	2,779 lm	113 lm/W	2,869 lm	116 lm/W	2,988 lm	121 lm/W	2,988 lm	121 lm/W			
HZV2-3L-U-XX-SACL	3,244 lm	131 lm/W	3,349 lm	136 lm/W	3,489 lm	141 lm/W	3,489 lm	141 lm/W			
HZV2-4L-U-XX-RAFL	3,877 lm	122 lm/W	4,002 lm	126 lm/W	4,169 lm	132 lm/W	4,169 lm	132 lm/W	32W	>80	2T8
HZV2-4L-U-XX-SAFL	3,814 lm	120 lm/W	3,937 lm	124 lm/W	4,101 lm	129 lm/W	4,101 lm	129 lm/W			
HZV2-4L-U-XX-SACL	4,039 lm	131 lm/W	4,268 lm	135 lm/W	4,445 lm	140 lm/W	4,445 lm	140 lm/W			
HZV2-4L-U-XX-SPFL	3,529 lm	111 lm/W	3,643 lm	115 lm/W	3,795 lm	120 lm/W	3,795 lm	120 lm/W			
HZV2-4L-U-XX-SACL	4,025 lm	130 lm/W	4,253 lm	134 lm/W	4,430 lm	140 lm/W	4,430 lm	140 lm/W			
HZV2-6L-U-XX-RAFL	4,968 lm	124 lm/W	5,128 lm	128 lm/W	5,342 lm	134 lm/W	5,342 lm	134 lm/W	40W	>80	3T8
HZV2-6L-U-XX-SAFL	4,887 lm	122 lm/W	5,044 lm	126 lm/W	5,254 lm	131 lm/W	5,254 lm	131 lm/W			
HZV2-6L-U-XX-SACL	5,297 lm	133 lm/W	5,468 lm	137 lm/W	5,696 lm	142 lm/W	5,696 lm	142 lm/W			
HZV2-6L-U-XX-SPFL	4,522 lm	113 lm/W	4,668 lm	117 lm/W	4,862 lm	122 lm/W	4,862 lm	122 lm/W			
HZV2-6L-U-XX-SACL	5,279 lm	132 lm/W	5,449 lm	136 lm/W	5,676 lm	142 lm/W	5,676 lm	142 lm/W			
HZV4-3L-U-XX-RAFL	2,822 lm	134 lm/W	2,913 lm	138 lm/W	3,034 lm	144 lm/W	3,034 lm	144 lm/W	21W	>80	1T8
HZV4-3L-U-XX-SAFL	2,775 lm	132 lm/W	2,865 lm	136 lm/W	2,984 lm	142 lm/W	2,984 lm	142 lm/W			
HZV4-3L-U-XX-SACL	3,009 lm	143 lm/W	3,106 lm	148 lm/W	3,235 lm	154 lm/W	3,235 lm	154 lm/W			
HZV4-3L-U-XX-SPFL	2,568 lm	122 lm/W	2,651 lm	126 lm/W	2,762 lm	131 lm/W	2,762 lm	131 lm/W			
HZV4-3L-U-XX-SACL	2,998 lm	142 lm/W	3,095 lm	147 lm/W	3,224 lm	153 lm/W	3,224 lm	153 lm/W			
HZV4-4L-U-XX-RAFL	3,789 lm	132 lm/W	3,911 lm	137 lm/W	4,074 lm	142 lm/W	4,074 lm	142 lm/W	29W	>80	2T8
HZV4-4L-U-XX-SAFL	3,727 lm	130 lm/W	3,847 lm	134 lm/W	4,007 lm	140 lm/W	4,007 lm	140 lm/W			
HZV4-4L-U-XX-SACL	4,040 lm	141 lm/W	4,170 lm	146 lm/W	4,344 lm	152 lm/W	4,344 lm	152 lm/W			
HZV4-4L-U-XX-SPFL	3,449 lm	120 lm/W	3,560 lm	124 lm/W	3,708 lm	129 lm/W	3,708 lm	129 lm/W			
HZV4-4L-U-XX-SACL	4,026 lm	141 lm/W	4,156 lm	145 lm/W	4,329 lm	151 lm/W	4,329 lm	151 lm/W			
HZV4-5L-U-XX-RAFL	4,818 lm	127 lm/W	4,993 lm	132 lm/W	5,201 lm	137 lm/W	5,201 lm	137 lm/W	38W	>80	1T5HO
HZV4-5L-U-XX-SAFL	4,758 lm	125 lm/W	4,911 lm	129 lm/W	5,116 lm	135 lm/W	5,116 lm	135 lm/W			
HZV4-5L-U-XX-SACL	5,158 lm	136 lm/W	5,324 lm	140 lm/W	5,546 lm	146 lm/W	5,546 lm	146 lm/W			
HZV4-5L-U-XX-SPFL	4,403 lm	116 lm/W	4,545 lm	120 lm/W	4,734 lm	125 lm/W	4,734 lm	125 lm/W			
HZV4-5L-U-XX-SACL	5,140 lm	135 lm/W	5,306 lm	140 lm/W	5,527 lm	146 lm/W	5,527 lm	146 lm/W			
HZV4-6L-U-XX-RAFL	6,050 lm	128 lm/W	6,245 lm	132 lm/W	6,505 lm	137 lm/W	6,505 lm	137 lm/W	47W	>80	3T8
HZV4-6L-U-XX-SAFL	5,950 lm	126 lm/W	6,142 lm	130 lm/W	6,398 lm	135 lm/W	6,398 lm	135 lm/W			
HZV4-6L-U-XX-SACL	6,451 lm	136 lm/W	6,659 lm	141 lm/W	6,936 lm	146 lm/W	6,936 lm	146 lm/W			
HZV4-6L-U-XX-SPFL	5,506 lm	116 lm/W	5,684 lm	120 lm/W	5,921 lm	125 lm/W	5,921 lm	125 lm/W			
HZV4-6L-U-XX-SACL	6,428 lm	136 lm/W	6,636 lm	140 lm/W	6,912 lm	146 lm/W	6,912 lm	146 lm/W			
HZV4-7L-U-XX-RAFL	7,021 lm	127 lm/W	7,247 lm	131 lm/W	7,549 lm	137 lm/W	7,549 lm	137 lm/W	55W	>80	3T8
HZV4-7L-U-XX-SAFL	6,905 lm	125 lm/W	7,128 lm	129 lm/W	7,425 lm	134 lm/W	7,425 lm	134 lm/W			
HZV4-7L-U-XX-SACL	7,486 lm	135 lm/W	7,728 lm	140 lm/W	8,050 lm	146 lm/W	8,050 lm	146 lm/W			
HZV4-7L-U-XX-SPFL	6,390 lm	116 lm/W	6,596 lm	119 lm/W	6,871 lm	124 lm/W	6,871 lm	124 lm/W			
HZV4-7L-U-XX-SACL	7,460 lm	135 lm/W	7,701 lm	139 lm/W	8,022 lm	145 lm/W	8,022 lm	145 lm/W			
HZV4-8L-U-XX-RAFL	8,061 lm	132 lm/W	8,321 lm	136 lm/W	8,668 lm	142 lm/W	8,668 lm	142 lm/W	61W	>80	2T5HO
HZV4-8L-U-XX-SAFL	7,929 lm	129 lm/W	8,185 lm	134 lm/W	8,526 lm	139 lm/W	8,526 lm	139 lm/W			
HZV4-8L-U-XX-SACL	8,596 lm	140 lm/W	8,873 lm	145 lm/W	9,243 lm	151 lm/W	9,243 lm	151 lm/W			
HZV4-8L-U-XX-SPFL	7,337 lm	120 lm/W	7,574 lm	124 lm/W	7,890 lm	129 lm/W	7,890 lm	129 lm/W			
HZV4-8L-U-XX-SACL	8,566 lm	140 lm/W	8,842 lm	144 lm/W	9,211 lm	150 lm/W	9,211 lm	150 lm/W			

<sup>1</sup>Please refer to the DLC Qualified Products List at [www.Designlights.org/QPL](http://www.Designlights.org/QPL) to confirm specific product qualifications.

# HZV

## HAZARDOUS LOCATION LINEAR VAPOR TIGHT

SYSTEMS INFO <sup>1</sup>	3000K		3500K		4000K		5000K		Watts <sup>2</sup>	CRI	Replaces
	Part Numbers	Lumens	Efficacy	Lumens	Efficacy	Lumens	Efficacy	Lumens			
HZV4-9L-U-XX-RAFL	8,703 lm	133 lm/W	8,984 lm	137 lm/W	9,358 lm	143 lm/W	9,358 lm	143 lm/W	66W	>80	2T5HO
HZV4-9L-U-XX-SAFL	8,560 lm	131 lm/W	8,836 lm	135 lm/W	9,205 lm	141 lm/W	9,205 lm	141 lm/W			
HZV4-9L-U-XX-SACL	9,280 lm	142 lm/W	9,579 lm	146 lm/W	9,978 lm	152 lm/W	9,978 lm	152 lm/W			
HZV4-9L-U-XX-SPFL	7,921 lm	121 lm/W	8,177 lm	125 lm/W	8,518 lm	130 lm/W	8,518 lm	130 lm/W			
HZV4-9L-U-XX-SACL	9,248 lm	141 lm/W	9,546 lm	146 lm/W	9,944 lm	152 lm/W	9,944 lm	152 lm/W			
HZV4-10L-U-XX-RAFL	9,528 lm	131 lm/W	9,835 lm	136 lm/W	10,245 lm	141 lm/W	10,245 lm	141 lm/W	73W	>80	4T8
HZV4-10L-U-XX-SAFL	9,372 lm	129 lm/W	9,674 lm	133 lm/W	10,077 lm	139 lm/W	10,077 lm	139 lm/W			
HZV4-10L-U-XX-SACL	10,160 lm	140 lm/W	10,487 lm	145 lm/W	10,924 lm	151 lm/W	10,924 lm	151 lm/W			
HZV4-10L-U-XX-SPFL	8,672 lm	120 lm/W	8,952 lm	124 lm/W	9,325 lm	129 lm/W	9,325 lm	129 lm/W			
HZV4-10L-U-XX-SACL	10,124 lm	140 lm/W	10,451 lm	144 lm/W	10,886 lm	150 lm/W	10,886 lm	150 lm/W			
HZV4-12L-U-XX-RAFL	12,099 lm	130 lm/W	12,490 lm	134 lm/W	13,010 lm	139 lm/W	13,010 lm	139 lm/W	93W	>80	3T5HO
HZV4-12L-U-XX-SAFL	11,901 lm	128 lm/W	12,285 lm	132 lm/W	12,797 lm	137 lm/W	12,797 lm	137 lm/W			
HZV4-12L-U-XX-SACL	12,902 lm	138 lm/W	13,318 lm	143 lm/W	13,873 lm	149 lm/W	13,873 lm	149 lm/W			
HZV4-12L-U-XX-SPFL	11,013 lm	118 lm/W	11,368 lm	122 lm/W	11,842 lm	127 lm/W	11,842 lm	127 lm/W			
HZV4-12L-U-XX-SACL	12,857 lm	138 lm/W	13,271 lm	142 lm/W	13,824 lm	148 lm/W	13,824 lm	148 lm/W			
HZV8-6L-U-XX-RAFL	6,314 lm	136 lm/W	6,517 lm	140 lm/W	6,789 lm	146 lm/W	6,789 lm	146 lm/W	47W	>80	2T8
HZV8-6L-U-XX-SAFL	6,210 lm	134 lm/W	6,411 lm	138 lm/W	6,678 lm	144 lm/W	6,678 lm	144 lm/W			
HZV8-6L-U-XX-SACL	6,732 lm	145 lm/W	6,950 lm	150 lm/W	7,239 lm	156 lm/W	7,239 lm	156 lm/W			
HZV8-6L-U-XX-SPFL	5,747 lm	124 lm/W	5,932 lm	128 lm/W	6,179 lm	133 lm/W	6,179 lm	133 lm/W			
HZV8-6L-U-XX-SACL	6,709 lm	144 lm/W	6,925 lm	149 lm/W	7,214 lm	155 lm/W	7,214 lm	155 lm/W			
HZV8-8L-U-XX-RAFL	8,307 lm	132 lm/W	8,575 lm	137 lm/W	8,932 lm	142 lm/W	8,932 lm	142 lm/W	63W	>80	2T8
HZV8-8L-U-XX-SAFL	8,171 lm	130 lm/W	8,434 lm	134 lm/W	8,786 lm	140 lm/W	8,786 lm	140 lm/W			
HZV8-8L-U-XX-SACL	8,858 lm	141 lm/W	9,143 lm	146 lm/W	9,524 lm	152 lm/W	9,524 lm	152 lm/W			
HZV8-8L-U-XX-SPFL	7,561 lm	120 lm/W	7,805 lm	124 lm/W	8,130 lm	130 lm/W	8,130 lm	130 lm/W			
HZV8-8L-U-XX-SACL	8,827 lm	141 lm/W	9,112 lm	145 lm/W	9,491 lm	151 lm/W	9,491 lm	151 lm/W			
HZV8-10L-U-XX-RAFL	9,802 lm	129 lm/W	10,118 lm	133 lm/W	10,540 lm	138 lm/W	10,540 lm	138 lm/W	76W	>80	3T5HO
HZV8-10L-U-XX-SAFL	9,641 lm	127 lm/W	9,952 lm	131 lm/W	10,367 lm	136 lm/W	10,367 lm	136 lm/W			
HZV8-10L-U-XX-SACL	10,452 lm	137 lm/W	10,789 lm	142 lm/W	11,239 lm	147 lm/W	11,239 lm	147 lm/W			
HZV8-10L-U-XX-SPFL	8,922 lm	117 lm/W	9,210 lm	121 lm/W	9,594 lm	126 lm/W	9,594 lm	126 lm/W			
HZV8-10L-U-XX-SACL	10,416 lm	137 lm/W	10,752 lm	141 lm/W	11,200 lm	147 lm/W	11,200 lm	147 lm/W			
HZV8-12L-U-XX-RAFL	10,968 lm	135 lm/W	11,321 lm	139 lm/W	11,793 lm	145 lm/W	11,793 lm	145 lm/W	81W	>80	6T8
HZV8-12L-U-XX-SAFL	10,788 lm	133 lm/W	11,136 lm	137 lm/W	11,600 lm	143 lm/W	11,600 lm	143 lm/W			
HZV8-12L-U-XX-SACL	11,695 lm	144 lm/W	12,072 lm	148 lm/W	12,575 lm	155 lm/W	12,575 lm	155 lm/W			
HZV8-12L-U-XX-SPFL	9,983 lm	123 lm/W	10,305 lm	127 lm/W	10,734 lm	132 lm/W	10,734 lm	132 lm/W			
HZV8-12L-U-XX-SACL	11,654 lm	143 lm/W	12,030 lm	148 lm/W	12,531 lm	154 lm/W	12,531 lm	154 lm/W			
HZV8-14L-U-XX-RAFL	13,468 lm	130 lm/W	13,903 lm	134 lm/W	14,482 lm	140 lm/W	14,482 lm	140 lm/W	103W	>80	6T8
HZV8-14L-U-XX-SAFL	13,247 lm	128 lm/W	13,675 lm	132 lm/W	14,245 lm	138 lm/W	14,245 lm	138 lm/W			
HZV8-14L-U-XX-SACL	14,361 lm	139 lm/W	14,825 lm	143 lm/W	15,442 lm	149 lm/W	15,442 lm	149 lm/W			
HZV8-14L-U-XX-SPFL	12,259 lm	119 lm/W	12,654 lm	122 lm/W	13,182 lm	127 lm/W	13,182 lm	127 lm/W			
HZV8-14L-U-XX-SACL	14,311 lm	138 lm/W	14,773 lm	143 lm/W	15,389 lm	149 lm/W	15,389 lm	149 lm/W			
HZV8-16L-U-XX-RAFL	15,218 lm	130 lm/W	15,709 lm	134 lm/W	16,363 lm	139 lm/W	16,363 lm	139 lm/W	117W	>80	4T5HO
HZV8-16L-U-XX-SAFL	14,968 lm	127 lm/W	15,451 lm	132 lm/W	16,095 lm	137 lm/W	16,095 lm	137 lm/W			
HZV8-16L-U-XX-SACL	16,227 lm	138 lm/W	16,750 lm	143 lm/W	17,448 lm	149 lm/W	17,448 lm	149 lm/W			
HZV8-16L-U-XX-SPFL	13,851 lm	118 lm/W	14,298 lm	122 lm/W	14,894 lm	127 lm/W	14,894 lm	127 lm/W			
HZV8-16L-U-XX-SACL	16,170 lm	138 lm/W	16,692 lm	142 lm/W	17,387 lm	148 lm/W	17,387 lm	148 lm/W			
HZV8-18L-U-XX-RAFL	16,614 lm	136 lm/W	17,149 lm	140 lm/W	17,864 lm	146 lm/W	17,864 lm	146 lm/W	122W	>80	6T5HO
HZV8-18L-U-XX-SAFL	16,341 lm	133 lm/W	16,868 lm	138 lm/W	17,571 lm	144 lm/W	17,571 lm	144 lm/W			
HZV8-18L-U-XX-SACL	17,715 lm	145 lm/W	18,286 lm	150 lm/W	19,048 lm	156 lm/W	19,048 lm	156 lm/W			
HZV8-18L-U-XX-SPFL	15,122 lm	124 lm/W	15,609 lm	128 lm/W	16,260 lm	133 lm/W	16,260 lm	133 lm/W			
HZV8-18L-U-XX-SACL	17,654 lm	144 lm/W	18,223 lm	149 lm/W	18,982 lm	155 lm/W	18,982 lm	155 lm/W			
HZV8-24L-U-XX-RAFL	21,936 lm	136 lm/W	22,644 lm	140 lm/W	23,587 lm	146 lm/W	23,587 lm	146 lm/W	162W	>80	6T5HO
HZV8-24L-U-XX-SAFL	21,576 lm	133 lm/W	22,272 lm	138 lm/W	23,200 lm	144 lm/W	23,200 lm	144 lm/W			
HZV8-24L-U-XX-SACL	23,390 lm	145 lm/W	24,145 lm	149 lm/W	25,151 lm	156 lm/W	25,151 lm	156 lm/W			
HZV8-24L-U-XX-SPFL	19,966 lm	124 lm/W	20,610 lm	128 lm/W	21,469 lm	133 lm/W	21,469 lm	133 lm/W			
HZV8-24L-U-XX-SACL	23,309 lm	144 lm/W	24,061 lm	149 lm/W	25,064 lm	155 lm/W	25,064 lm	155 lm/W			

<sup>1</sup>Values are nominal, see IES file for more detail    <sup>2</sup>Electrical wdata at 25C (77F). Actual wattage may differ by +/- 10%.

\*Please refer to the DLC Qualified Products List at [www.Designlights.org/QPL](http://www.Designlights.org/QPL) to confirm specific product qualifications.

# HZV

## HAZARDOUS LOCATION LINEAR VAPOR TIGHT

### AMBIENT TEMPERATURE RANGE

Part Numbers	Suspended ( 18 in.)	Surface Mount
	Standard	Standard
HZV2-2L-U-XX-RAFL	-40°F to 127°F	-40°F to 126°F
HZV2-3L-U-XX-RAFL	-40°F to 122°F	-40°F to 112°F
HZV2-4L-U-XX-RAFL	-40°F to 115°F	-40°F to 103°F
HZV2-6L-U-XX-RAFL	-40°F to 110°F	-40°F to 96°F
HZV4-3L-U-XX-RAFL	-40°F to 132°F	-40°F to 130°F
HZV4-4L-U-XX-RAFL	-40°F to 129°F	-40°F to 122°F
HZV4-5L-U-XX-RAFL	-40°F to 127°F	-40°F to 115°F
HZV4-6L-U-XX-RAFL	-40°F to 126°F	-40°F to 113°F
HZV4-7L-U-XX-RAFL	-40°F to 125°F	-40°F to 111°F
HZV4-8L-U-XX-RAFL	-40°F to 124°F	-40°F to 108°F
HZV4-9L-U-XX-RAFL	-40°F to 122°F	-40°F to 104°F
HZV4-10L-U-XX-RAFL	-40°F to 130°F	-40°F to 119°F
HZV4-12L-U-XX-RAFL	-40°F to 129°F	-40°F to 118°F
HZV8-6L-U-XX-RAFL	-40°F to 122°F	-40°F to 117°F
HZV8-8L-U-XX-RAFL	-40°F to 129°F	-40°F to 115°F
HZV8-10L-U-XX-RAFL	-40°F to 127°F	-40°F to 115°F
HZV8-12L-U-XX-RAFL	-40°F to 124°F	-40°F to 120°F
HZV8-14L-U-XX-RAFL	-40°F to 125°F	-40°F to 111°F
HZV8-16L-U-XX-RAFL	-40°F to 122°F	-40°F to 110°F
HZV8-18L-U-XX-RAFL	-40°F to 145°F	-40°F to 133°F
HZV8-24L-U-XX-RAFL	-40°F to 122°F	-40°F to 107°F

### SPECIFICATIONS

#### CONSTRUCTION

Injection molded one piece 5VA rated fiberglass body with chemical resistant finish for rigidity, durability and prolonged life in rough environments. F1 weatherability rated housing. T4 Housing Ignition Temperature Rated. Toolless removable gear tray for quick and easy access to electrical. Captive latches fastened to housing to safely secure lens to housing. Designed to achieve maximum performance & improved aesthetics.

#### ELECTRICAL

Class 2 LED light engine for high efficacy and long life. Calculated L70> 100,000 hours. LED Lumen Maintenance Estimates based on TM-21 projections for the light source at 25C ambient. Power Factor > 0.90. Standard 120-277 Vac 0-10V dimmable (10% - 100%) with optional 347V -480 Vac High Voltage Driver. 6kV Surge Protection Standard. Optional emergency battery backup available to meet critical life safety lighting requirements. Fixture max ambient reduced for emergency battery backup.

#### INSTALLATION

Designed for a variety of mounting applications including surface, pendant, 45° wall mount and suspended. Pre-drilled holes on each side of fixture for electrical access and wiring. Hole plugged from factory with rubbered IP rated seal. ½" HUBS available for threaded power entry from both ends. Toolless hinged removable gear tray for quick and easy access to electrical.

#### WARRANTY

5 Year Warranty (Terms and Conditions apply)

#### OPTICS

Robust injection molded and impact resistant PMMA lens options for durability and LED glare reduction. Standard Ribbed Acrylic Frosted (RAFL), with optional Smooth Acrylic Frosted (SAFL), Smooth Acrylic Clear (SACL), Smooth Polycarbonate Frosted (SPFL) and Smooth Polycarbonate Clear (SPCL) lens options. Field removeable lens for easy access to LED boards, drivers and maintenance.

#### THERMAL

Ambient temperature range -40°F up to 131°F (-40°C to 55°C) on select models with cold start ambient temperature options. Fixture to be mounted at a minimum plenum height of 18" for suspended mounting. Reduced maximum ambient for surface mounting. Reference Ambient Temperature Ratings by lumen package in the Ambient Temperature Range table for more detail.

#### CERTIFICATIONS

ETL Listed to US and Canadian safety standards. Suitable for Wet Locations. American Recovery and Reinvestment Act Funding Compliant. BAA Compliant. Hazardous Location Class 1 Division 2, Groups A, B, C, D. Class 1 Zone 2 Groups IIA, IIB + H2, IIC. UL844 Hazardous. IP65, IP66, IP67 Rated. NSF Listed. 1500 PSI Hosedown Rated. DLC (DesignLights Consortium) Premium Qualified. Please refer to the DLC Qualified Products List at [www.Designlights.org/QPL](http://www.Designlights.org/QPL) to confirm specific product qualifications.

# HZV

## HAZARDOUS LOCATION LINEAR VAPOR TIGHT

### MOUNTING OPTIONS

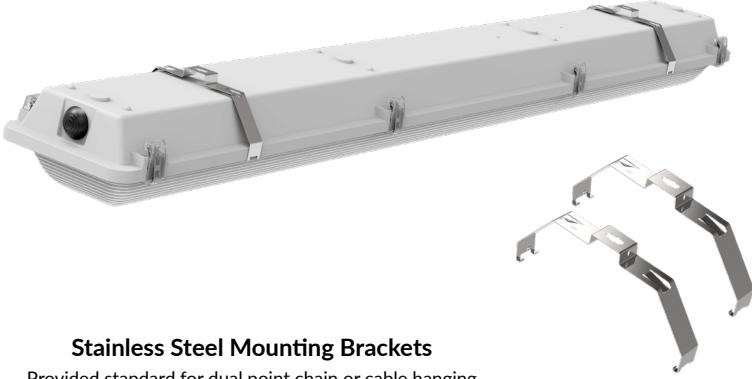

#### Stainless Steel Mounting Brackets

Provided standard for dual point chain or cable hanging



#### AB45DEG

45° Stainless Steel Angled Wall Mount Bracket. Two standard per set. One set required per fixture.



#### ACxY

Includes 2 adjustable cable hangers.  
Available in 5' and 10'.  
Stainless Steel Options Available.

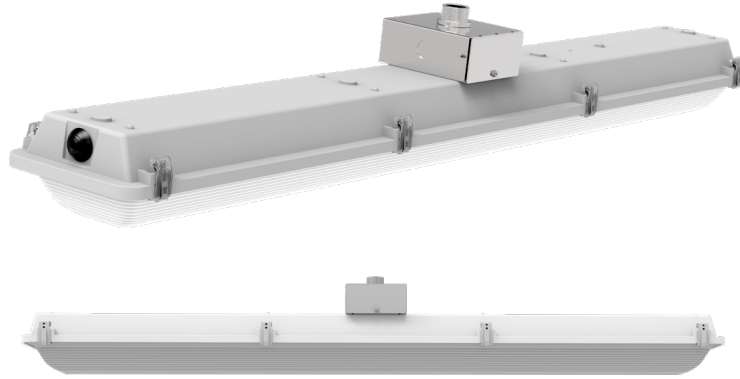

#### FMB

Fixture Mounting Box utilized when pendant mounting. Must be used with HZ-HUB 3/4. One needed per 4ft section.



#### HZ-HUB 3/4

HZ-HUB 3/4 - 3/4" Conduit Hub for Single Pendant Mounting. Requires use of FMB

# HZV

## HAZARDOUS LOCATION LINEAR VAPOR TIGHT

### LINE DRAWINGS

#### HZV2:

Top View

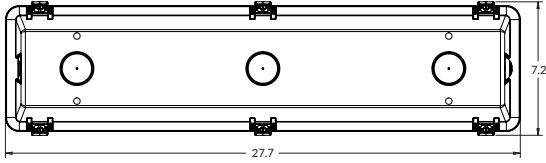

End View

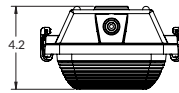

LENS TYPE:  
RAFL

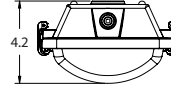

LENS TYPE:  
SAFL  
SACL  
SPFL  
SPCL

Side View

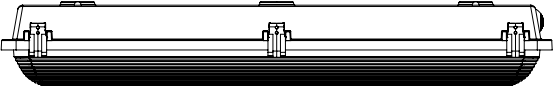

#### HZV4

Top View

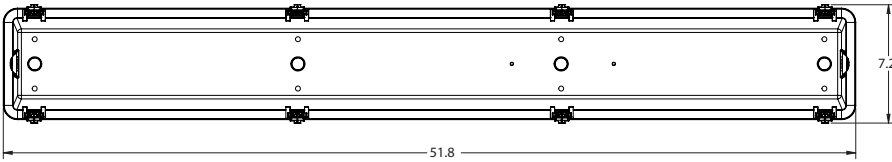

End View

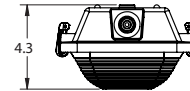

LENS TYPE:  
RAFL

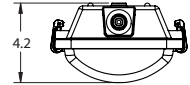

LENS TYPE:  
SAFL  
SACL  
SPFL  
SPCL

Side View



#### HZV8

Top View

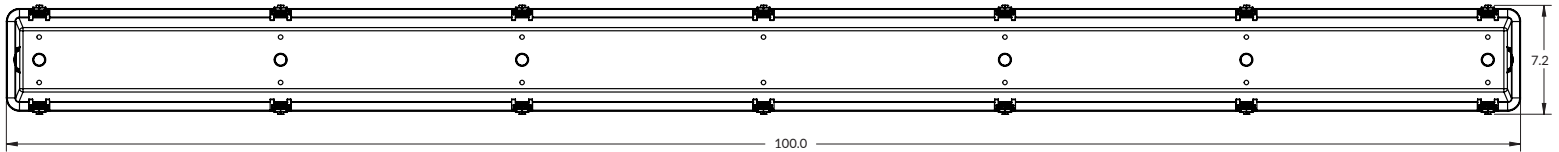

Side View

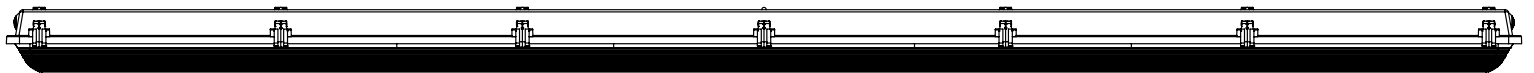

End View

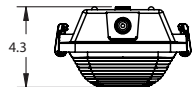

LENS TYPE:  
RAFL

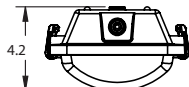

LENS TYPE:  
SAFL  
SACL  
SPFL  
SPCL

# HZV

## HAZARDOUS LOCATION LINEAR VAPOR TIGHT

### PHOTOMETRIC DATA

LUMINAIRE DATA	
Part Number	HZV2-4L-U-50-RAFL
Description	2ft Hazardous Location Linear Vapor Tight, 4,000 Lumens, Ribbed Frosted Acrylic Lens
Fixture Lumens (lm)	4,172 lm
Wattage (W)	80 W
Efficacy (lm/W)	164 lm/W
Mounting	Suspended
Spacing Criteria	0° = 1.30, 90° = 1.29

ZONAL LUMEN SUMMARY		
Zone	Lumens (lm)	% Fixture
0° - 40°	1,744	42%
0° - 60°	3,043	73%
0° - 90°	4,010	96%
90° - 180°	162	4%
0° - 180°	4,172	100%

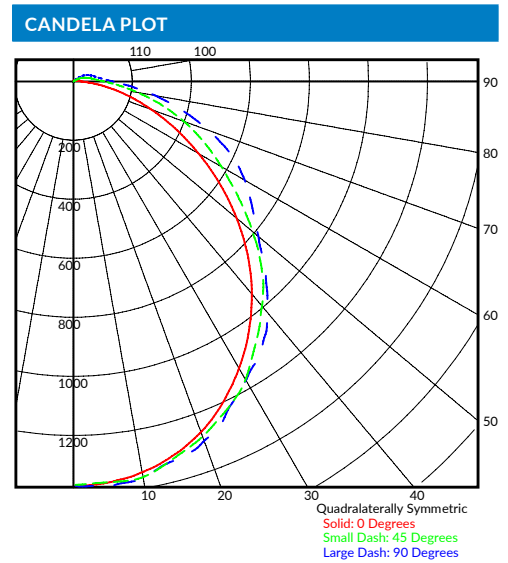

LUMINAIRE DATA	
Part Number	HZV4-8L-U-50-RAFL
Description	4ft Hazardous Location Linear Vapor Tight, 4,000 Lumens, Ribbed Frosted Acrylic Lens
Fixture Lumens (lm)	8,673 lm
Wattage (W)	80 W
Efficacy (lm/W)	152 lm/W
Mounting	Suspended
Spacing Criteria	0° = 1.29, 90° = 0.77

ZONAL LUMEN SUMMARY		
Zone	Lumens (lm)	% Fixture
0° - 40°	3,626	42%
0° - 60°	6,327	73%
0° - 90°	8,338	96%
90° - 180°	336	4%
0° - 180°	8,673	100%

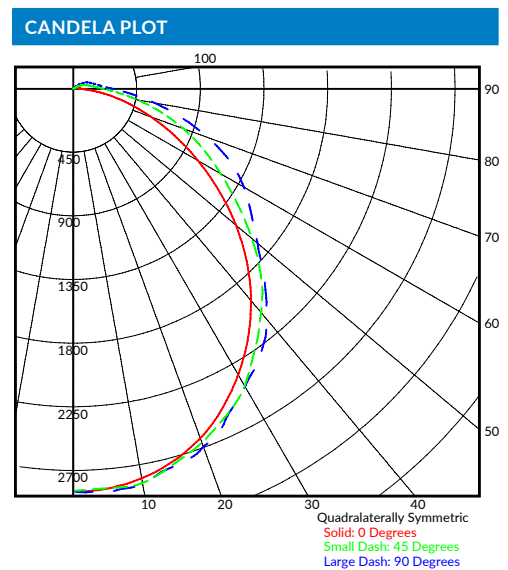

LUMINAIRE DATA	
Part Number	HZV8-16L-U-50-RAFL
Description	8ft Hazardous Location Linear Vapor Tight, 4,000 Lumens, Ribbed Frosted Acrylic Lens
Fixture Lumens (lm)	16,371 lm
Wattage (W)	80 W
Efficacy (lm/W)	159 lm/W
Mounting	Suspended
Spacing Criteria	0° = 1.26, 90° = 1.26

ZONAL LUMEN SUMMARY		
Zone	Lumens (lm)	% Fixture
0° - 40°	6,845	42%
0° - 60°	11,944	73%
0° - 90°	15,737	96%
90° - 180°	634	4%
0° - 180°	16,371	100%

