

LEDH-310ICA

3.5" Low Voltage LED IC Rated New Construction Recessed Housing

| | | |
|-------------|--|------|
| Catalog # | | Type |
| Project | | Date |
| Prepared by | | |

MR16 LED Blub

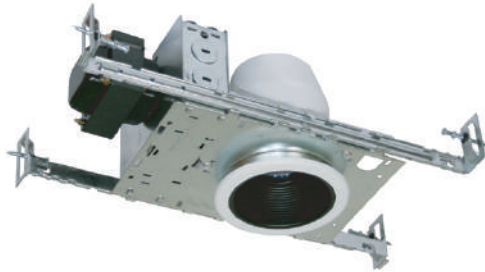

DESCRIPTION

The LEDH-310ICA is 3.5" low voltage LED housing for accent task lighting.

APPLICATION

The LEDH-310ICA is designed for insulated ceilings and can be in direct contact with insulation material. The LEDH-310ICA offers a wide choice of trim types including reflector, lensed and wall wash trims. This AIR-TIGHT housing design prevents airflow through the ceiling, helping save on heating and cooling costs.

DESIGN FEATURES

Housing

- Galvanized steel housing painted white.
- 5-1/2" height allows use in 2"X6" joist construction.
- Housing adjusts for ceilings up to 1-1/4" thick.

Junction Box

- Listed for through branch circuit wiring.
(Max.8 No 12 AWG 90°C branch circuit conductors.(4 in, 4 out))
- (5)1/2" knockouts with true pry-out slots and (4) knockouts with Romex cable clamp.
- Ground wire provided on J-box.

Mounting Frame

- Galvanized steel construction.
- 8" L X 5-1/2" W

Transformer

- 120V magnetic transformer steps line voltage down to lamp operating voltage for lamps up to 15W Max.
- Available 277V-12V transformer.

Lamp

- LED MR16 12V 12.2W Max.(Not Included)

Bar Hangers

- Maximum extension of 24" allows for extra distance between joists.
- Housing can be positioned at any point within 24" joist span.
- Score lines allow "toolless" shortening for 12" joists. Bar hangers may be repositioned 90 degrees.
- Integral T-bar clips snaps onto T-bars and no additional clips are required.

Socket

- GU5.3 Ceramic Bi-Pin Socket.

Optional "Quick Connect" Push-in wire connectors.

- Three "Quick Connectors"
- Pre-installed push-in wire connectors for fast and easy wiring.

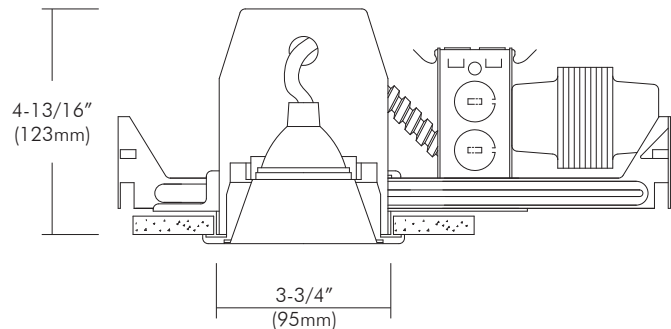

Ceiling Cut-out : 3-7/8"
Lamp, Max, Watt. : 12.2W

Listing ETL listed for damp location.

Recommended Dimmer



* Lutron: D i v a (Dv-600P)
Skylark (S -600P)
Ariadni (AY-600P)

**Consult tech. service or factory
for additional dimmers**

TRIMS

For LEDH-310ICA, LEDH-310ICAR

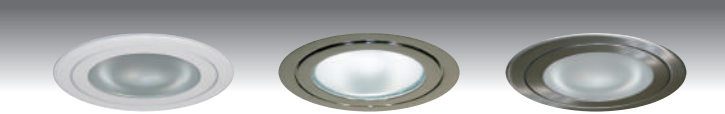
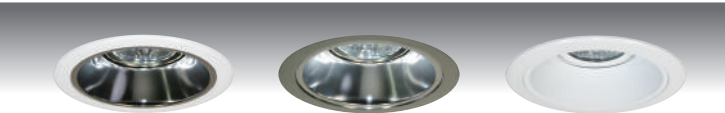
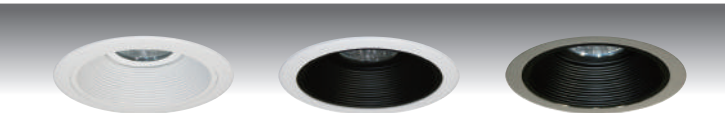

MR16 LED Blub

| | | | |
|---|---|--|--|
| <p>LT-350 Shower Frosted Flat Lens Die-Cast Construction O.D : 4-5/16"</p> |  <p style="text-align: center;"> LT-350WH LT-350CH LT-350SN </p> | | |
| <p>LT-351 Shower Convex Shape Lens Die-Cast Construction O.D : 4-5/16"</p> |  <p style="text-align: center;"> LT-351WH LT-351CH LT-351MO </p> | | |
| <p>LT-352 Tapered Glass Diffuser Die-Cast Construction O.D : 4-5/16"</p> |  <p style="text-align: center;"> LT-352WH LT-352WH-B LT-352BK </p> | | |
| <p>LT-354 Adjustable Reflector Die-Cast Construction O.D : 4-5/16"</p> |  <p style="text-align: center;"> LT-354CL LT-354CL-CH LT-354WH </p> | | |
| <p>LT-355 Adjustable Baffle Die-Cast Construction O.D : 4-5/16"</p> |  <p style="text-align: center;"> LT-355WH LT-355BK LT-355BK-CH </p> | | |
| <p>LT-358 Pin Spot w/ Baffle Die-Cast Construction O.D : 4-5/16"</p> |  <p style="text-align: center;"> LT-358BK LT-358BK-SN LT-358BK-MO </p> | | |
| <p>LT-359 Pin Spot w/Reflector Die-Cast Construction O.D : 4-5/16"</p> |  <p style="text-align: center;"> LT-359CL LT-359BK-SN LT-359BK-MO </p> | | |
| <p>LT-360 Slotted Wall Wash Die-Cast Construction O.D : 4-5/16"</p> |  <p style="text-align: center;"> LT-360WH LT-360SN LT-360MO </p> | | |

TRIMS

For LEDH-310ICA, LEDH-310ICAR

MR16 LED Blub

| | | |
|---------------|--|---|
| LT-361 | Adjustable Wall Wash w/Baffle Die-Cast Construction O.D : 4-5/16" |  <div style="display: flex; justify-content: space-around; text-align: center;"> <div data-bbox="841 506 961 534">LT-361WH</div> <div data-bbox="1078 506 1198 534">LT-361PB</div> <div data-bbox="1300 506 1421 534">LT-361MO</div> </div> |
| LT-362 | Dropped Clear Etched Lens Die-Cast Construction O.D : 4-5/16" |  <div style="display: flex; justify-content: space-around; text-align: center;"> <div data-bbox="841 715 961 742">LT-362WH</div> <div data-bbox="1078 715 1198 742">LT-362BK</div> <div data-bbox="1300 715 1421 742">LT-352SN</div> </div> |
| LT-364 | Gimbal w/Baffle Die-Cast Construction O.D : 4-5/16" |  <div style="display: flex; justify-content: space-around; text-align: center;"> <div data-bbox="841 923 961 951">LT-364WH</div> <div data-bbox="1057 923 1208 951">LT-364BK-SN</div> <div data-bbox="1284 923 1451 951">LT-364BK-MO</div> </div> |

ORDERING INFORMATION

| Housing | Trim | Reflector | Baffle | Metal Ring |
|-----------------------------|--|---|---|---|
| LEDH-310ICA LEDH-310ICAR | LT-350 LT-359 LT-351 LT-360 LT-352 LT-361 LT-354 LT-362 LT-355 LT-364 LT-358 | -CL : clear -WH : white -GD : gold -MA : matte platinum -CP : champagne -PR : pewter -HC : haze clear | -WH : white -BK : black -SN : satin nickel -AN : antique nickel -AC : antique copper -MO : mocha -CA : cappuccino | -CH : chrome -UN : natural steel -PB : polished brass |

Example : LEDH-310ICA-LT-361-WH