



# TP120-347-RT8-C-DIM-G1-ES

## 8" Round Commercial 3 CCT & 3 Wattage Selectable

### DESCRIPTION

All in one solution 8" round recessed commercial grade LED fixture  
Perfect for hospitality, shopping mall & retail, office, exterior soffit, etc.

### FEATURES & BENEFITS

- User selectable 3 light colors & 3 power options
- Universal voltage 120V-347V input
- 0-10V Dimmable 5%-100%
- CRI 90+ for true color rendering
- Type IC, Wet location & Air-tight
- Regressed optics with low glare
- Suitable for new construction and retrofit applications

**DIMENSIONS** ID 7 7/8" OD 10 1/4" Regressed 2"  
Cut Out 7 7/8" to 9 1/2"

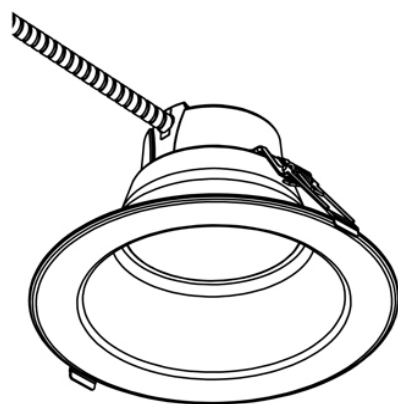
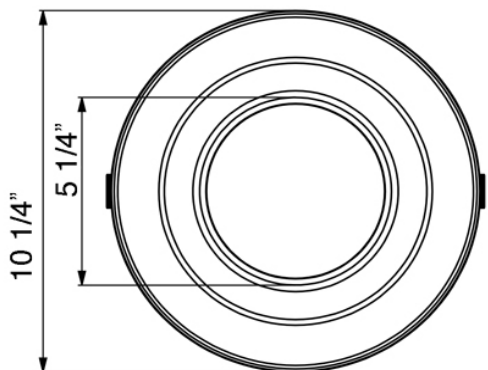
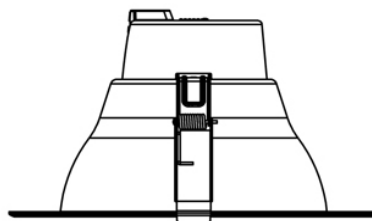
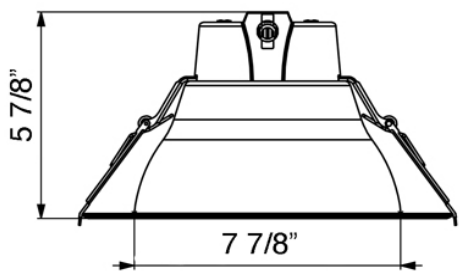
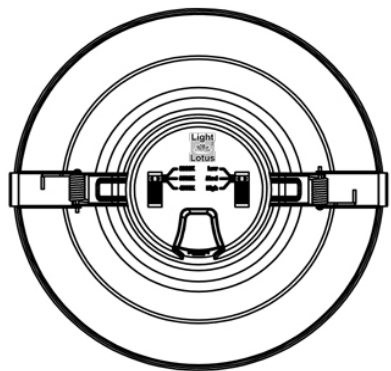

### ORDERING GUIDE

**TP120-347-RT8-C-DIM-G1-ES**  
**TP120-347-RT8-C-DIM-G1-ES-AZ**

Trim / Reflector

[White](#)

[Alzak](#)

Project:

Location:

Trim:

Qty:

Notes:

SPECIFICATION	
Applications	Commercial Recessed Ceiling
Power Levels (W)	10   15   22
Light Output (lm)	1000   1500   2000
Color Temperature (K)	3CCT: 3000K - 3500K - 4000K
Beam Angle	90°
CRI	90 +
Input	120V-347V AC 50/60 Hz
Dimming	0 - 10V
Approved Location	Insulated Ceiling & Wet Locations
Air Tight	Yes
Ambient Temperature	-4°F (-20°C) to +104°F (+40°C)
Projected Life	70% Light Output at 50,000 Hours
Certification	cETLus, Energy Star, T24
Warranty	5 Year

### Trim Options

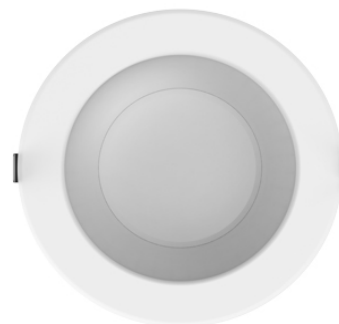

[Matte White](#)

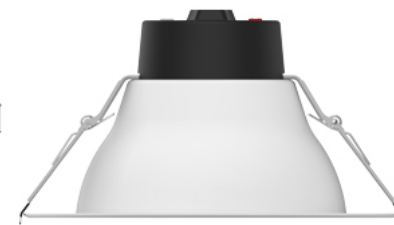

[Alzak \(White Trims & Matte Silver Reflector\)](#)



### ACCESSORIES

Sold Separately



Black trim cover model # [LBL-8CRT-B](#)



Silver trim cover model # [LBL-8CRT-S](#)



Goof Ring White OD 12 1/2" model # [LBL-8CGR-W](#)

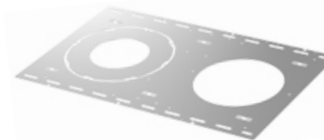

New Construction Mounting Plate for Stud Ceiling  
model # [LBL-MP-C4-8-STUD](#)

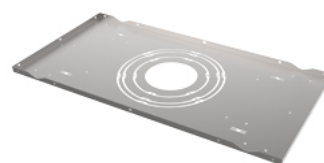

New Construction Mounting Plate for T-bar Ceiling  
model # [LBL-MP-C4-10-TBAR](#)

Please note that junction box is not included

### COMPLIANCE

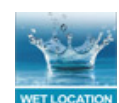

Type IC  
Air-Tight

Lotus LED Lights USA  
250 H Street # 301, Blaine WA 98230 tel 360-200-5500  
Hainesport NJ, Naples FL, Vancouver WA

[www.LotusLEDLights.com](http://www.LotusLEDLights.com)  
mailing addresses  
warehouses

Lotus LED Lights CANADA  
702 Chester Rd, Delta BC V3M 6J1 tel 604-538-3090  
Delta BC & Mississauga ON