



JOB NAME:

CAT#:

TYPE:

APPLICATIONS

The PWL downlight fixture is perfect for distinctive architectural lighting plans. It is ideal for lobbies, bathrooms, and office areas, and can be installed individually or in group patterns.

FEATURES & BENEFITS

- Surface mountable
- Available in black, white, or silver finish
- 5 year warranty



DIMENSIONS

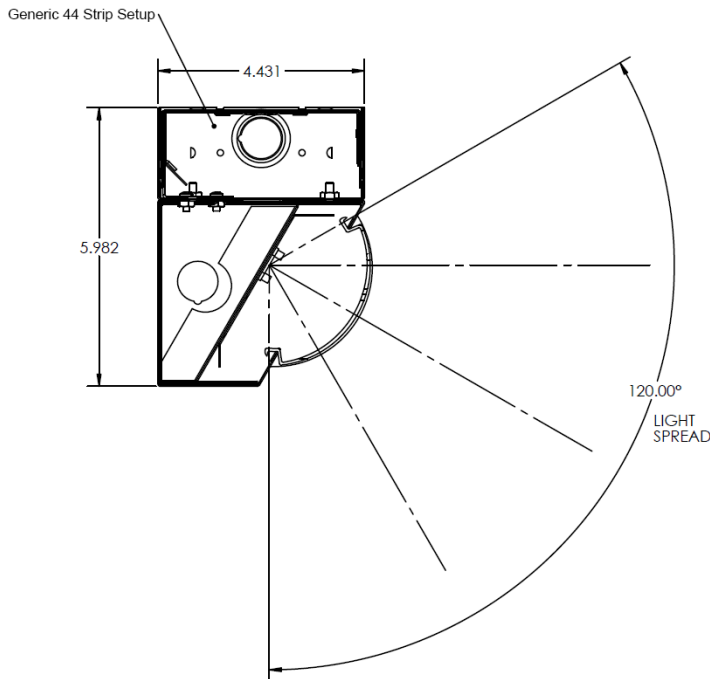

Dimensions and specifications subject to change without notice.





JOB NAME:

CAT#:

TYPE:

ORDERING

EXAMPLE: PWL FR 48 LED 30 DMV WH 40 P11

PWL			LED				
1. SERIES	2. LENS	3. SIZE	4. GEAR	5. WATTAGE/LUMENS	5. DRIVER	6. FINISH	7. COLOR TEMP
PWL	FR Frosted	48 48 inches	LED	30 30 Watts 4100 Lumens 48 48 Watts 6000 Lumens 57 57 Watts 6900 Lumens	DMV 0-10V Dimming 120-277VAC Multivolt SDMV Step Dimming 120-277VAC 100%-40% D120 120V Dimmable D347V 347VAC 0-10V Dimmable D277 Triac Dimming 277VAC	WH White BK Black SI Silver	40 4000K 50 5000K

8. WIRE

- P11** 3 wire harness, including white, black, and green
- P12** 4 wire harness, including white, black, green, and blue for emergency battery backup
- P13D** 5 wire harness, including white, black, green, violet, and gray

Dimensions and specifications subject to change without notice.



JOB NAME:

CAT#:

TYPE:

PHOTOMETRICS

ESBO

ESBE

ESBG

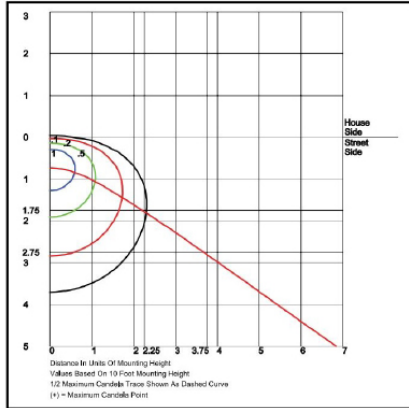

Grid in MH
MH=10 Feet

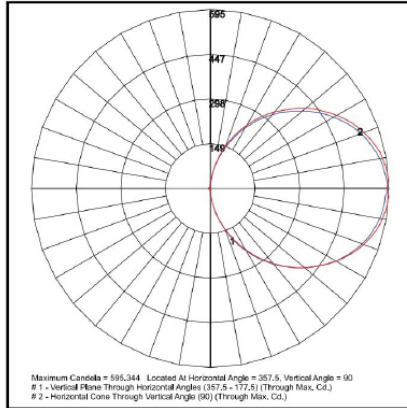

Grid in MH
MH=10 Feet

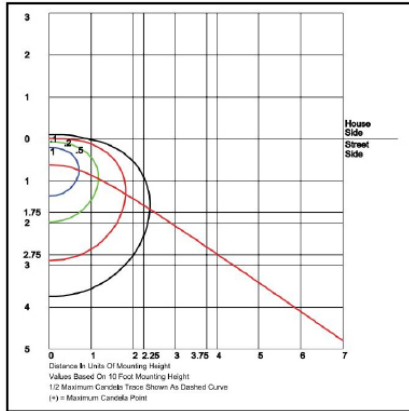

Grid in MH
MH=10 Feet

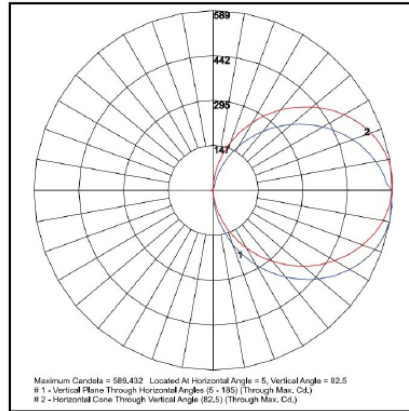

Grid in MH
MH=10 Feet

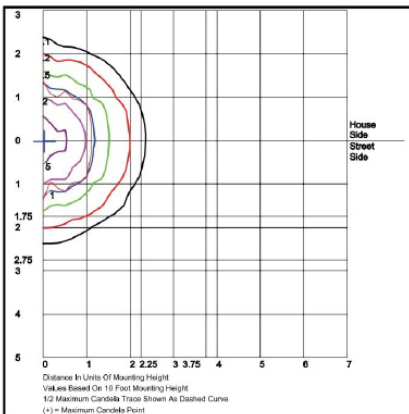

Grid in MH
MH=10 Feet

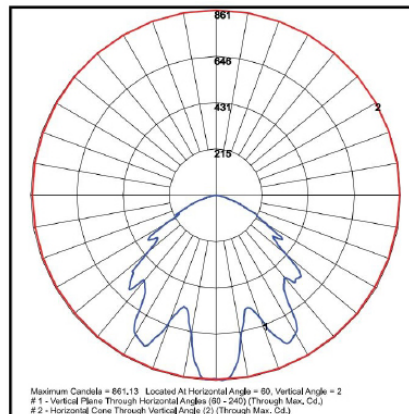

Grid in MH
MH=10 Feet

Dimensions and specifications subject to change without notice.

