

Catalog #:	
Project :	
Type :	Date:
Notes:	

LED Mini-Strip & Retrofit Kit / Low Bay

STMN1™ Series

DESCRIPTION

Dual Qualified Strip & Retrofit Kit available in 2', 3', & 4' length's. Up to 30pcs. linkable. 100% Mercury & Lead Free.

APPLICATIONS

Ideal for general utility applications: Troffers, garage, display shops, movable lighting, case lighting, storage units, stair-well. Connect individual or in continuous rows.



QUICK SHIP:

DM-STMN2FT10W-40K DM-STMN2FT10W-50K
DM-STMN4FT18W-40K DM-STMN4FT18W-50K

Specification Features



Controls / Dimming

Luminaire is non-dimmable. Frosted PC Lens with 240° Beam Angle.

Warranty

5 Years Limited Warranty. See warranty documentation for more information. Rated for 50,000+ Hours (*50,000 hours real-world means 5.7 years if the light is worked for 24 hours in a day, 7.6 years if the lights are on 18 hours per day, etc...*).

Electrical

High lighting efficacy. Reliable internal driver is Non-dimming. Standard voltage (120V) for commercial application. Reduces energy consumption up to 60%

Certification

It complies with cETL, CE, RoHS, FCC, DLC Premium Listed, IP44 Rated.

Installation / Mounting

Suitable for Nut Fixed mounting, Surface mounting, Suspension mounting, Magnetic mounting for installation.

Ordering Information

Example: DM-STMN4FT18W-50K-ZZ

DM	STMN	4FT	18W	50K	[Blank]	[Blank]
Brand	Series	Length	Nominal Wattage	Color Temp	Input Voltage	Dimming/Hz
DM	STMN LED MINI-Strip Light	2FT 2 Feet	10W 10 Watt	40K 4000K	Blank AC120V	Blank Non-Dimming, 50/60Hz
		3FT 3 Feet	12W 12 Watt	50K 5000K		
		4FT 4 Feet	15W 15 Watt			
			18W 18 Watt			
ZZ						
Mounting Options						
SFM	Surface Mount with Tapping Screw					
SPM	Suspension Mounting					
MGM	Magnetic Mounting					
LPC	Linking Power Cord					
LBC	Linking Butt Connector					
IPC	Incoming Power Cord					

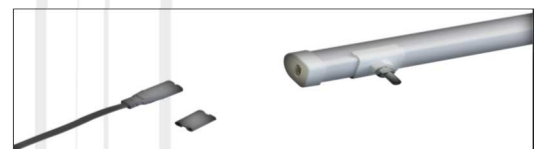
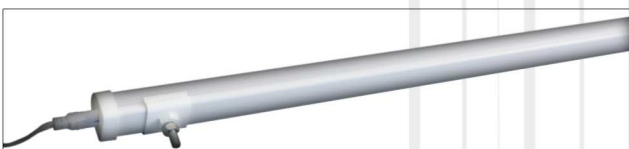

Lighting Parameters

Input Voltage	AC120
CCT	3000K / 4000K / 5000K
CRI	Ra>80
Luminous efficacy	130lm/w
PF	>0.90
Beam Angle	240°
IP Rating	IP44 Rated
Input Current	0.3A / 0.4A / 0.8A
Working temperature	-4°F~104°F
Storage temperature	-22°F~140°F
Size	2FT / 3FT/ 4FT

STMN-2	21.65" x 1.16" x 1.14" (L x W x H) Inch
STMN-3	33.46" x 1.16" x 1.14" (L x W x H) Inch
STMN-4	44.10" x 1.16" x 1.14" (L x W x H) Inch

Product Dimension

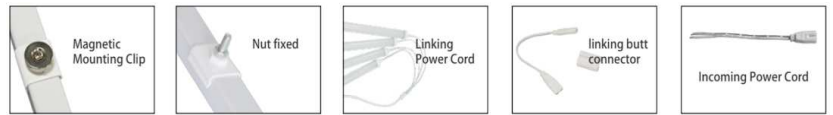
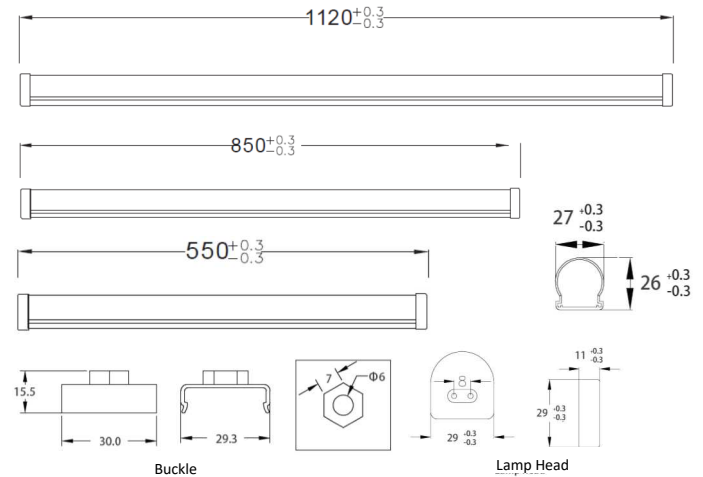

Photometric Data

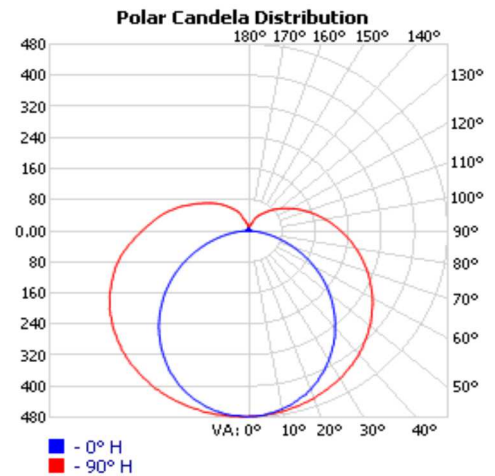
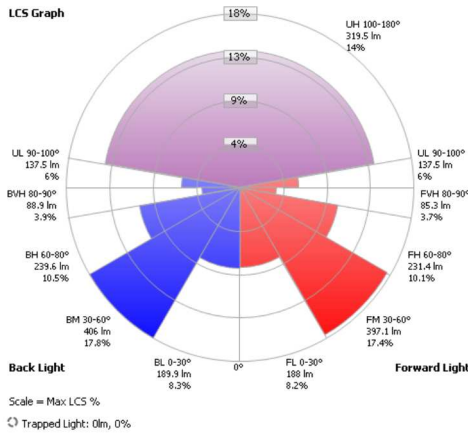

Installation Instruction

Surface Mounted Installation

1. Drill the holes where you want to fix the strip fixture and driver;

2. Fix the buckles properly by screws;

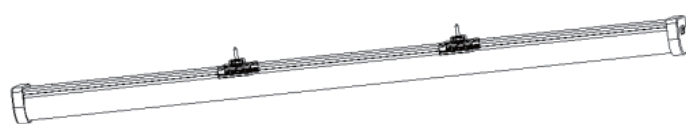

3. Put both the Strip fixture and driver into the grille box;

4. Connect AC wire by connector.

Installation Instruction

Nut Fixed Installation

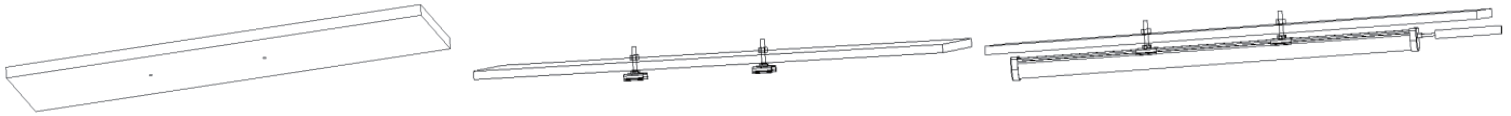

1. Drill 2 1/4" holes in the fixed plate;
2. Fix the buckle to the plate by nut;
3. Put the Mini-Strip Fixture to the buckle;
4. Connect AC Wire by connector

Wire Installation

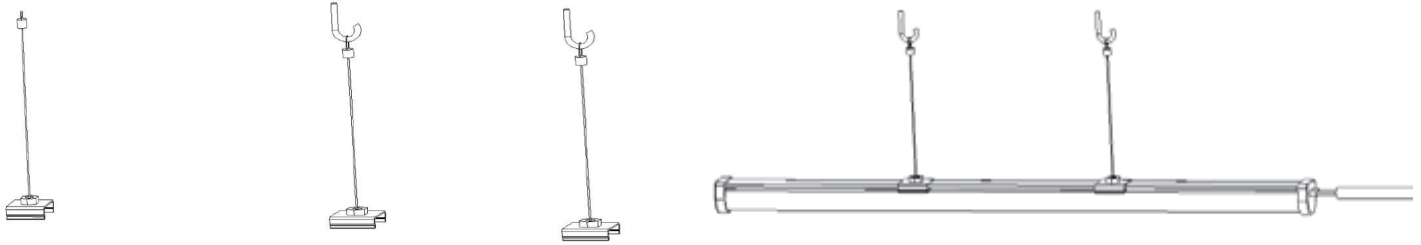

1. Connect the wire and buckle;
2. Fix the other side of the wire to a fixed
3. Put the Mini Strip in the buckle;
4. Connect AC Wire by connector

Magnetic Installation

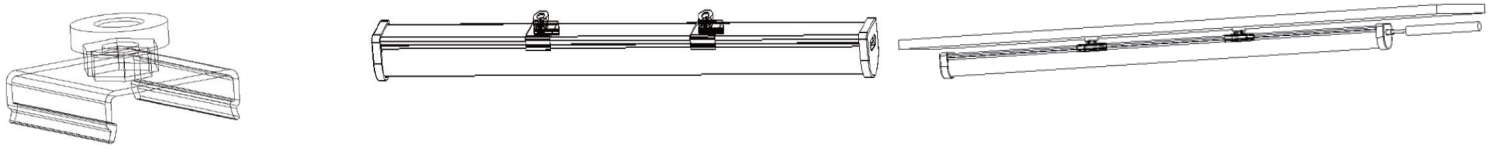

1. Connect the magnetic 2 pcs. and the 2 buckle pcs. with the nuts;
2. Fix the buckle with the Mini-Strip Fixture;
3. Put the Mini-Strip into steel product;
4. Connect the AC wire by connector.

Packing Information

Size	Inner Carton Size (L×W×H)	Outer Carton Size (L×W×H)	Qty/Carton (pcs)	N.W./Ctn (lbs)	G.W./Ctn (lbs)
2Ft	22.1 x *2.00" x 1.80"	26.7 x 8.26" x 7.87"	36	7.93	12.38
3Ft	34.0" x 2.00" x 1.80"	38.5" x 8.26" x 7.87"	36	12.16	17.19
4Ft	44.9" x 2.00" 1.80"	49.2" x 8.26" x 7.87"	36	15.53	21.12

Model	Description	Input Watts	Efficacy	Delivered Lumens	Voltage (VAC)	THD	CRI	Power Factor	DLC Product ID
DM-STMN2FT10W-40K	Mini Strip / Low Bay	10	136.89	1,300	120V	≤20%	80	>0.9	P28YR0RT
DM-STMN2FT10W-50K	Mini Strip / Low Bay	10	137.85	1,300	120V	≤20%	82	>0.9	PB64E1UE
DM-STMN4FT18W-40K	Mini Strip / Low Bay	18	129.30	2,321	120V	≤20%	80	>0.9	PJVDJKO1
DM-STMN4FT18W-50K	Mini Strip / Low Bay	18	131.39	2,358	120V	≤20%	80	>0.9	PJC9M7LT

