

Catalog #:	
Project :	
Type :	Date:
Notes:	

LED FLAT DISK PANEL LIGHT

TL-FDPL2™ SERIES

DESCRIPTION

Ultra-Slim Downlight Retrofit engineered for demanding commercial applications. Save up to 80% in energy cost. 100% Mercury & Lead Free.

APPLICATIONS

Ideal for lighting malls, hospitals, hotels, and retail spaces. Replaces CFL & HID or Incandescent downlights for higher energy savings & aesthetics.



QUICK SHIP:

- TL-FDPL2-5-9W-3CCT
- TL-FDPL2-9-18W-3CCT
- TL-FDPL2-12-24W-3CCT

SOFT WHITE	3000K
BRIGHT WHITE	4000K
DAYLIGHT	5000K

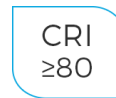

Specification Features

Controls / Dimming

High quality internal driver; Triac dimming; Flicker free. Frosted Lens and Non-IC, and rated for damp locations. SMD2835. Beam angle is 120°.

Warranty

5 Years Limited Warranty. See warranty documentation for more information.

Certification

It complies with ETL/ cETL certification, Energy Star Rated, and FCC.

Installation / Mounting

LED downlight retrofit is supplied with a quick connect-case and conduit to make an easy connection to an existing recessed fixture frame junction box. Beam angle is 120°. Instant start w/NO humming.

Ordering Information

Example: TL-FDPL2-9-18W-3CCT

TL	FDPL2	9	18W	50K	[BLANK]
Brand	Series	Diameter	Nominal Wattage	Color Temp	Diffuser Type
TL TechnoLED	FDPL2 Flat Disk Panel Light	5 5 Inch 9 9 Inch 12 12 Inch	9W 9 Watt 12W 12 Watt 18W 18 Watt 24W 24 Watt	3CCT Tunable 3000K / 4000K /5000K	[Blank] Frosted [Blank] 110-120V

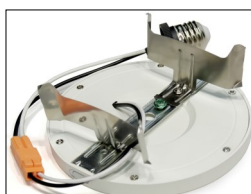

Lighting Parameters

Input Voltage	AC120V
CCT	3CT (3000K / 4000K / 5000K)
CRI	Ra>80
Luminous efficacy	80 lm/w
PF	0.90
Driver Efficiency	87%
THD	20%
Working temperature	-4°F~104°F
Storage temperature	-22°F~140°F
IP Rating	IP20

Part Number	L	W	H
TL-FDPL1/2-5-9W	5.5"	5.5"	0.7"
TL-FDPL1/2-9-18W	9.0"	9.0"	0.7"
TL-FDPL1/2-12-24W	12"	12"	0.7"

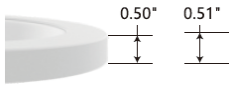

Product Dimension

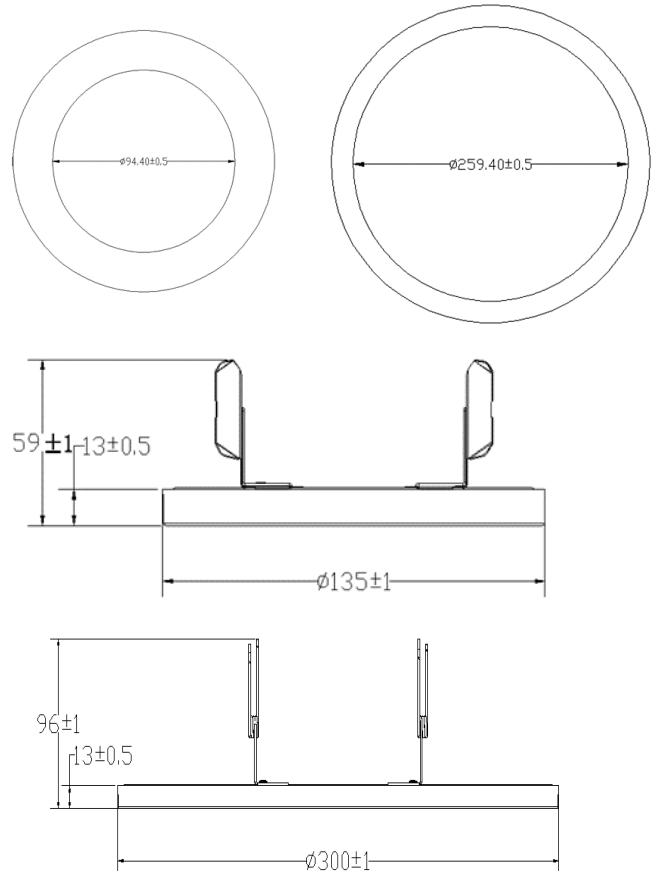

Photometric data

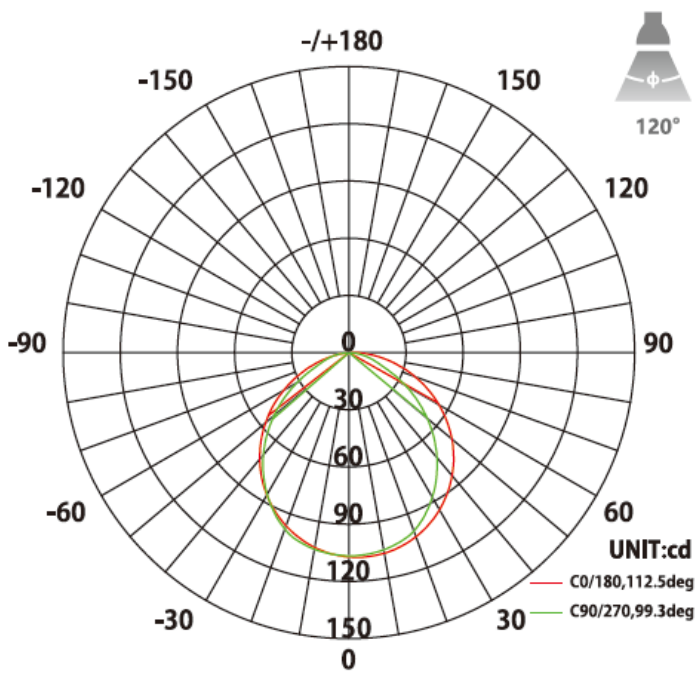

AVERAGE BEAM ANGLE(50%):105.9 DEG

Flux out:305.4 lm

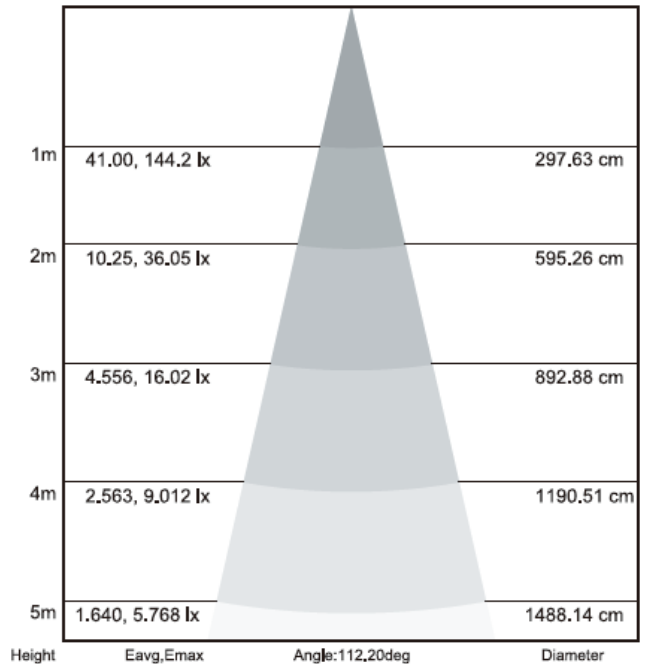

Note: The Curves indicate the illuminated area and the average illumination when the luminaire is at different distance.

Installation Instruction

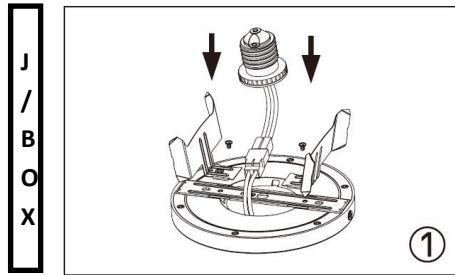

Remove trim and existing lamp from recessed fixture;

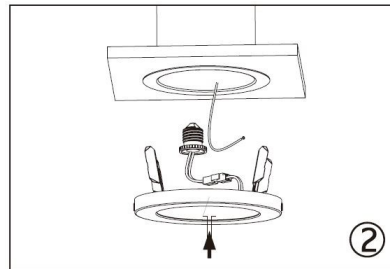

Screw E26 Socket adapter into socket in housing;

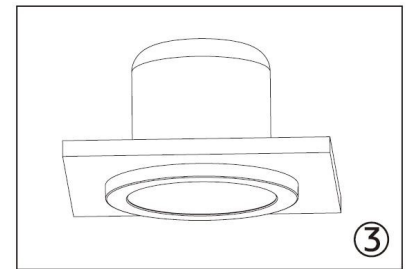

Press the friction blade to insert the lamp into the housing and restore power.

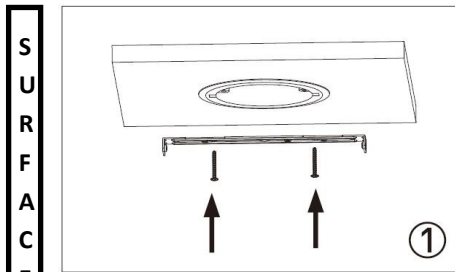

Fixing bracket on terminal box;

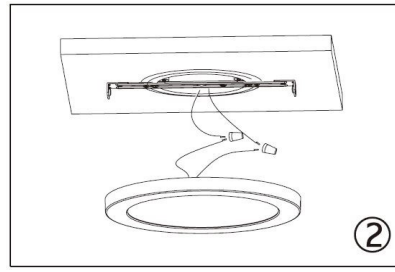

Connecting the wires;

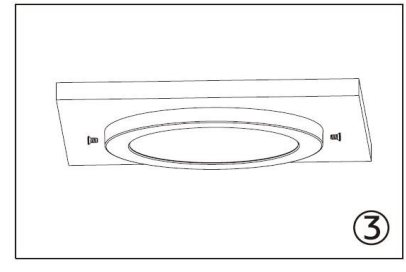

Fixing the lamp body on bracket and fix tightly.

Product and Packing Information

Model	Outer Carton Size (L×W×H)	Qty/Carton (pcs)	N.W./Ctn (lbs)	G.W./Ctn (lbs)
TL-FDPL2-5-9W	12.0" x 11.6" x 11.8"	60	29 lbs.	32 lbs.
TL-FDPL2-9-18W	18.7" x 8.3" x 9.5"	20	26 lbs.	29 lbs.
TL-FDPL2-12-24W	12.6" X 08.3" x 12.6"	10	26 lbs.	29 lbs.

Model	Description	Input Watts	Delivered Lumens	Universal Voltage (VAC)	Max Line Current (Amp) @ 120 - 277	THD	Power Factor	Weight
TL-FDPL2-5-9W	Flat Disk Panel Light 5 inch	9	650	120	80mA	30%	>0.9	0.45 lbs.
TL-FDPL2-9-18W	Flat Disk Panel Light 9 inch	18	1,440	120	170mA	30%	>0.9	1.02 lbs.
TL-FDPL2-12-24W	Flat Disk Panel Light 12 inch	24	1,920	120	220mA	30%	>0.9	2.20 lbs.

