

GOLD CUP MD LED

Architectural Outdoor



PROJECT:	
TYPE:	
PO#:	QTY:
COMMENTS:	



FEATURES

- Cast Aluminum Housing w/ Textured Polyester Bronze Powder Coat Finish
- Ribbed Borosilicate Glass Diffuser
- Fully Gasketed
- Stainless Steel Zinc-Coated Screws
- Mounts Direct to Flat Surface w/ Four #8 Wall Anchors (Not Included)
- Cast-In Template
- L70 Life Time For 50,000hr
- CSA Listed Wet Location For Wall Mounting
- Emergency Battery Available
- LED Light Fixture
- Mounting Hardware Included

LINE DRAWING

LINE DRAWING NOT TO SCALE

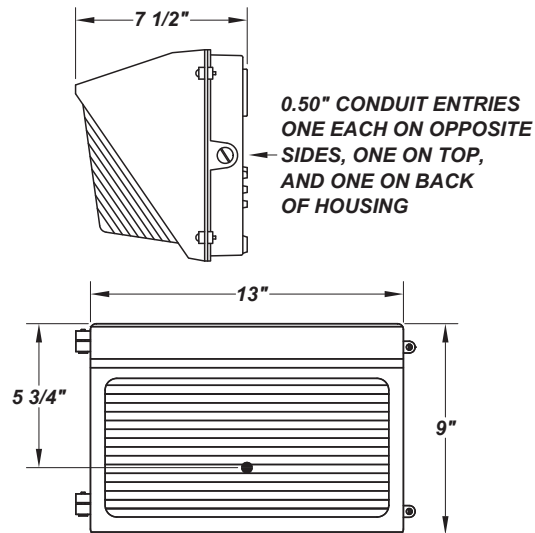

FINISHES

Antique
Copper



Antique
Silver

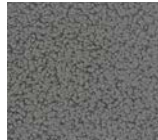

Bronze
Mist



Matte
Silver

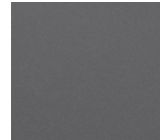

Metallic
Black

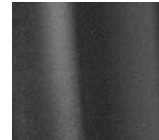

Sand

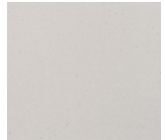

Swedish
Steel



Textured
Black

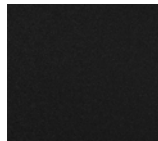

Textured
Bronze

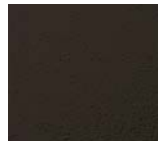

Textured
White



For RAL Colors
& Custom
Match -
Contact Teron
Lighting Inc.

GOLD CUP MD LED

Architectural Outdoor



Fixture Core

PROJECT:	
TYPE:	
PO#:	QTY:
COMMENTS:	

PRODUCT CODE	SOURCE/WATTAGE	VOLTAGE	DIMMING BALLAST
GPM - Gold Cup MD	L35.0 - 35W LED Module	100 - 277V	Not Applicable
ORDER INFO			
GPM	L35.0	100 - 277V	Not Applicable

Example ^ (may not represent a manufacturable product)

Aesthetics & Options

TRIM	FINISH	COLOR TEMP	OPTIONS
Not Applicable	AC - Antique Copper AS - Antique Silver BT - Bronze Mist MB - Metallic Black SM - Matte Silver SN - Sand SW - Swedish Steel TB - Textured Black	BZ - Textured Bronze (Standard) TW - Textured White 40K - 4000K Color Temp 50K - 5000K Color Temp	CGL - Clear Glass Lens (Standard) DIM - Dimmable Driver (0 - 10V) PDIM - Pulse Width Dimmable Driver (0 - 10V) SDIM - Step-Dimmable Driver (Dimmable to 25% and 50%) PCL120 - Photocell 120V PCL277 - Photocell 277V LXS - Lexan Lens Shield WGD - Steel Wire Guard TP - Tamper-Proof Screw Set F - Fused EB - Bodine BSL23 - Will light Two 5.5W LED Strips (Please Specify Voltage)
ORDER INFO			
Not Applicable	AC	40K	CGL

Example ^ (may not represent a manufacturable product)

PROD	SOURCE	40K SPECS	50K SPECS
GPM	L35.0	<ul style="list-style-type: none"> 80 CRI Typ. 40K - 4000K Color Temp 3990 LED Source Lumens 114 LED Source Lumens Per Watt 	<ul style="list-style-type: none"> 80 CRI Typ. 50K - 5000K Color Temp 4200 LED Source Lumens 120 LED Source Lumens Per Watt

REPLACEMENT PART	PART NO	NOTES
Ribbed Borosilicate Glass Diffuser	37127	Don't see the configuration you are looking for? Call us today at (513) 858-6004
Frosted Ribbed Borosilicate Glass Diffuser	3712762	
Internal Visor (Please Specify Color When Ordering)	5300799	



TERONLIGHTING.COM
 33 DONALD DR, FAIRFIELD, OH 45014
 P: 513.858.6004 F: 513.858.6038
 E: SALES@TERONLIGHT.COM



We reserve the right to revise the design components of any product due to parts availability or change in UL standards, without assuming any obligation or liability to modify any products previously manufactured, and without notice.