

# ROYAL LED

Architectural Outdoor



PROJECT:	
TYPE:	
PO#:	QTY:
COMMENTS:	



## FEATURES

- Steel Fascia w/ Textured Black Polyester Powder Coat Finish
- Luminous White 75% DR Acrylic Diffuser
- Steel Mounting Pan w/ Hi-Reflectance White Powder Coat Finish
- Aluminum Reflector
- Mounts Directly to 4" Junction Box (By Others)
- CSA Listed Wet Location
- LED Light Fixture
- Mounting Hardware Included



## LINE DRAWING

LINE DRAWING NOT TO SCALE

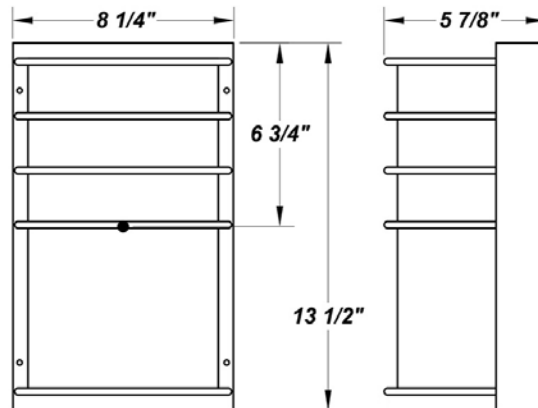

## FINISHES

Antique Copper

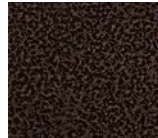

Antique Silver

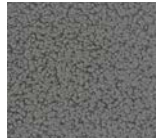

Bronze Mist



Matte Silver

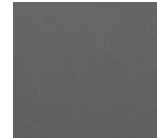

Metallic Black

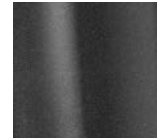

Sand

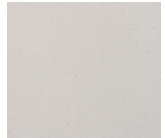

Swedish Steel



Textured Black

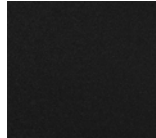

Textured Bronze

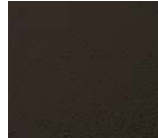

Textured White



For RAL Colors & Custom Match - Contact Teron Lighting Inc.

# ROYAL LED

Architectural Outdoor



Fixture Core

PROJECT:	
TYPE:	
PO#:	QTY:
COMMENTS:	

PRODUCT CODE	SOURCE/WATTAGE	VOLTAGE	DIMMING DRIVER
RL - Royal	<b>L15.0-TE600</b> - 15.0W @ 600mA ELV Dimming Driver <b>L18.0-TE700</b> - 18.0W @ 700mA ELV Dimming Driver <b>L18.0-ZE700</b> - 18.0W @ 700mA Line Voltage 4-Wire Dimming Driver (Dimmable 0 - 10V)	<b>120V</b> <b>277V</b> (50 / 60Hz)	<b>Not Applicable</b>
ORDER INFO			
RL	L15.0-TE600	120V	Not Applicable

Example ^ (may not represent a manufacturable product)

Aesthetics & Options

TRIM	FINISH	COLOR TEMP	OPTIONS
<b>Not Applicable</b>	<b>AC</b> - Antique Copper <b>AS</b> - Antique Silver <b>BT</b> - Bronze Mist <b>BN</b> - Brushed Nickel <b>SM</b> - Matte Silver <b>MB</b> - Metallic Black <b>SN</b> - Sand <b>SW</b> - Swedish Steel <b>TB</b> - Textured Black (Standard) <b>BZ</b> - Textured Bronze <b>TW</b> - Textured White	<b>27K</b> - 2700K Color Temp <b>30K</b> - 3000K Color Temp <b>35K</b> - 3500K Color Temp <b>40K</b> - 4000K Color Temp	<b>F</b> - Fused <b>TP</b> - Tamper Resistant Screws
ORDER INFO			
Not Applicable	AC	27K	F

Example ^ (may not represent a manufacturable product)

PROD	SOURCE	30K SPECS				
RL	L15.0	<ul style="list-style-type: none"> <li>30K - 3000K Color Temp</li> <li>2048 LED Source Lumens</li> <li>136.5 LED Source Lumans Per Watt</li> </ul>				
	L18.0	<ul style="list-style-type: none"> <li>30K - 3000K Color Temp</li> <li>2390 LED Source Lumens</li> <li>132.8 LED Source Lumans Per Watt</li> </ul>				

REPLACEMENT PART	PART NO	NOTES
White 75% DR Acrylic Lens	3051060	

Don't see the configuration you are looking for?  
Call us today at (513) 858-6004



TERONLIGHTING.COM  
 33 DONALD DR, FAIRFIELD, OH 45014  
 P: 513.858.6004 F: 513.858.6038  
 E: SALES@TERONLIGHT.COM



We reserve the right to revise the design components of any product due to parts availability or change in UL standards, without assuming any obligation or liability to modify any products previously manufactured, and without notice.

# ROYAL LED

Architectural Outdoor



Fixture Core

PROJECT:	
TYPE:	
PO#:	QTY:
COMMENTS:	

PRODUCT CODE	SOURCE/WATTAGE	VOLTAGE	DIMMING DRIVER
RL - Royal	L30.0-ZE1050 - 30.0W @ 1050mA Line Voltage 4-Wire Dimming Driver (Dimmable 0 - 10V)	120V 277V (50 / 60Hz)	Not Applicable
ORDER INFO			
RL	L15.0-TE600	120V	Not Applicable

Example ^ (may not represent a manufacturable product)

Aesthetics & Options

TRIM	FINISH	COLOR TEMP	OPTIONS
Not Applicable	<b>AC</b> - Antique Copper <b>AS</b> - Antique Silver <b>BT</b> - Bronze Mist <b>BN</b> - Brushed Nickel <b>SM</b> - Matte Silver <b>MB</b> - Metallic Black <b>SN</b> - Sand <b>SW</b> - Swedish Steel <b>TB</b> - Textured Black (Standard) <b>BZ</b> - Textured Bronze <b>TW</b> - Textured White	<b>27K</b> - 2700K Color Temp <b>30K</b> - 3000K Color Temp <b>35K</b> - 3500K Color Temp <b>40K</b> - 4000K Color Temp	<b>F</b> - Fused <b>TP</b> - Tamper Resistant Screws
ORDER INFO			
Not Applicable	AC	27K	F

Example ^ (may not represent a manufacturable product)

PROD	SOURCE	30K SPECS			
RL	L30.0	<ul style="list-style-type: none"> <li>30K - 3000K Color Temp</li> <li>3585 LED Source Lumens</li> <li>119.5 LED Source Lumans Per Watt</li> </ul>			

REPLACEMENT PART	PART NO	NOTES
White 75% DR Acrylic Lens	3051060	

Don't see the configuration you are looking for?  
Call us today at (513) 858-6004



TERONLIGHTING.COM  
33 DONALD DR, FAIRFIELD, OH 45014  
P: 513.858.6004 F: 513.858.6038  
E: SALES@TERONLIGHT.COM



We reserve the right to revise the design components of any product due to parts availability or change in UL standards, without assuming any obligation or liability to modify any products previously manufactured, and without notice.