

2/22/2015

Vaporproof Strip - 8 Foot

1, 2, 4 or 6 Lamps



Vaporproof Fluorescent

Applications

- | | |
|--------------------|---------------------|
| Entrance Lighting | Beverage Industry |
| Car Washes | Food Processing |
| Public Access | Construction Sites |
| Parking Structures | Industrial Lighting |

Certifications



Dimensional Drawings

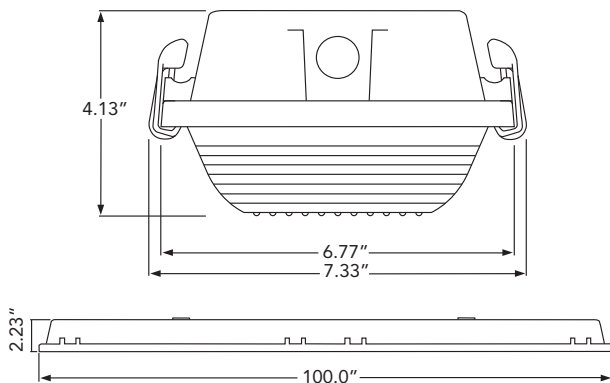

Specifications subject to change without notice.

Project:	
Catalog#:	
Approved by:	

Description

VSA8 series 8' fluorescent vaporproof strip fixture is gasketed to provide dust and moisture resistant illumination. This fixture operates one to six lamps, and as a standard feature, it comes with a Howard ballast.

Features

Housing

- One-piece upper body; no seams to crack, break, or leak
- Reinforced fiberglass body is rugged and corrosion resistant
- 5VA Flammability Rating
- White plastic latches standard
- Fourteen latches for positive lens retention
- Latches designed to accept screws to make enclosure tamper resistant
 - White Plastic latches accepts #4 - 1/2" screw
 - Stainless steel latches accepts #6 - 3/8" screw
- White polyethylene molded end plugs for use as knockouts
- High gloss, baked enamel reflective front

Gasket

- Closed cell polyester gasket
- Poured gasket seamlessly fills channel for maximum seal
- Gasket has dry skin that will not stick to the mating surface
- High gasket compression recovery ensures a solid seal over life of fixture

Diffuser

- Injection molded for maximum strength and precise detail
- Lineal prisms on sides reduce glare
- Continuous formed perimeter provides for positive seal
- Materials:
 - 100% Virgin Impact Resistant Acrylic
 - Long lasting clarity and resistance to weathering
- Acrylic/DR blend for superior impact resistance, long life and clarity
- Ribbed geometry designed for maximum strength
- Continuous formed perimeter provides for positive seal

Installation

- Shipped fully wired with Howard ballast
- Easy access to wiring compartment and ballast via removable gear tray
- Gear tray tethered to housing by two lanyards for extra safety
- Knockouts on each end
- Spring-mount, stainless steel bracket allows for surface or chain mount
- Brackets install first, then snap securely onto fixture
- NEC compliant luminaire power disconnect standard

Ballast

- Electronic, Inherent Thermal Protection, Class P, Sound rated A
- UL Listed

Quality Assurance

- System Tested, Designed, Approved, and Manufactured by Howard Lighting Products in Mendenhall, Mississippi.

Vaporproof Strip - 8 Foot 1, 2, 4 or 6 Lamps

Project:	
Catalog#:	
Approved by:	

Ordering Information

Model Family	Lens	No. of Lamps	Lamp Type/Wattage ⁽³⁾	CRI/CCT					Ballast	Input Volts	Factory Installed Options	Cordset Options	T B A	Pack.
VSA8	A	2	59	A					SI	MV	000	00	0	I
VSA8	A: Impact resistant acrylic	8-Foot Lamps 1 ⁽¹⁾ 2	28: F28T8 30: F30T8 32: F32T8	CRI	CCT	High Lumen	T8	T5	8-Foot Lamps RS: 8-ft T12 HO SBF Rapid Start	MV: 120-277v AX: 480-277 ⁽⁶⁾	000: No FIOs E: Enhanced specular aluminum reflector H: Chain hanging bracket I: Special Wiring Instructions S: Stainless steel latches	00: Standard Disconnect 01: 6', no plug 02: 10', no plug 03: 6', twist lock 120v 04: 10' twist lock 120v 05: 6' non twist lock 120v 06: 10' non twist lock 120v 07: 6' twist lock 277v 08: 10' twist lock 277v 09: 6' non twist lock 277v 10: 10' non twist lock 277v 11: 16/3, no plug spec len 12: 16/4, no plug spec len 16: 16', non twist lock 277v 17: 18/3, no plug spec len 18: 6', twist lock 480v 19: 10', twist lock 480v 20: 16', twist lock 120v 21: 16', twist lock 277v		I: Single
		4-Foot Lamps 2 4 ⁽²⁾ 6 ⁽²⁾	28: F28T5 54: F54T5HO 59: F96T8 (8') ⁽⁴⁾ 9S: F96T12 (8') ⁽⁴⁾ 9H: F96T12HO (8') ⁽⁴⁾	A: No Lamps B: 75 3000 C: 75 3500 D: 75 4100 E: 75 5000 F: 85 3000 G: 85 3500 H: 85 4100 I: 85 5000 J: 85 6500 K: 85 3000 L: 85 3500 M: 85 4100 N: 85 5000					SI: 8-ft T8/T12 SBF Instant Start 4-Foot Lamps SE: SBF High Eff ⁽⁵⁾ HE: HBF High Eff ⁽⁵⁾ LE: LBF High Eff ⁽⁵⁾ PS: PRS T5 P8: PRS T8 ⁽⁵⁾					

(1) Fixture is designed to accept two 8' lamps. In one-lamp installation, the lamp is offset to one side, not in the center of the fixture.

(2) Tandem 4' lamps

(3) Lamp installation available.

(4) Consult factory for availability of 8' T8 and T12 lamps. Two lamp maximum.

(5) High Efficiency ballasts are CEE Listed.

(6) Step-down autotransformer. Allows hook-up of standard MV ballast to 480v.

Table 1:

SE	Standard Ballast Factor High Efficiency Instant Start T8 Ballast
HE	High Ballast Factor High Efficiency Instant Start T8 Ballast
LE	Low Ballast Factor High Efficiency Instant Start T8 Ballast
PS	Program Rapid Start T5 Ballast
P8	Program Rapid Start High Efficiency T8 Ballast

Sample Ordering Number:
VSA8 A 2 59A SI MV 000 00 I
 VSA8 Series 8-Foot Vaporproof Strip
 Impact resistant acrylic lens
 2-lamps (none installed)
 F96T8 59W Standard Ballast Factor Ballast
 Multi-volt (120-277v)
 No Factory Installed Options
 No Cordset
 Single Packaging

**RAPID SHIP MODELS
 AVAILABLE FOR NEXT DAY SHIPMENT**

- VSA8A432ASEMV000000I
- VSA8A54APSMV000000I

Specifications subject to change without notice.

2/22/2015

Project:	
Catalog#:	
Approved by:	

Options Available



VS-CB

Chain Bail

(2 needed per fixture,
order separately)

Vaporproof Fluorescent

Energy Cost Estimator					
		Existing System		New System	
		M2/110RS-277		VSA8A432ASE Standard Ballast Factor Fluorescent Strip	
Hours burned per year	4368	Number of Fixtures	1	Number of Fixtures	1
Cost per kWh\$	0.12	Watts per Fixture (existing system)	209	Watts per Fixture (new system)	108
Energy Cost Estimation		Energy used per year (existing system)	\$110	Energy used per year (new system)	\$57
		Energy saving per year (per fixture)		\$53.00	

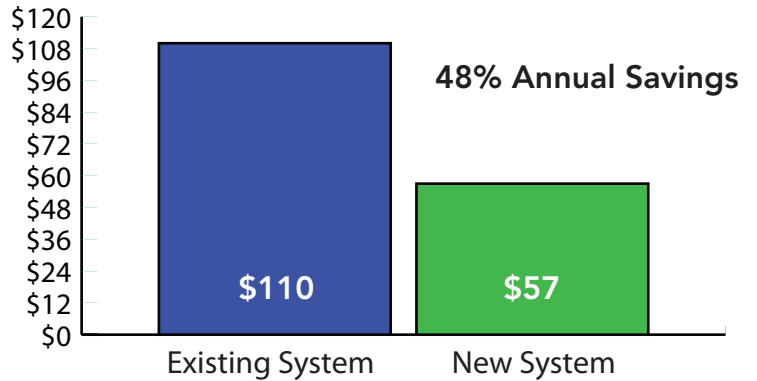

Howard Industries provides this tool to examine the potential impact of lighting decisions. This tool provides an ESTIMATE only. The analysis of this tool does not warrant or guarantee the actual costs or savings that will be realized as the analysis suggested. You can find the full version of this cost saving tool at the Howard Lighting Website—www.howardlightingproducts.com. Click "Cost of Ownership Calculator".
Copyright (c) 2008 Howard Industries All Rights Reserved.

Specifications subject to change without notice.

2/22/2015

Vaporproof Fluorescent

Hardware - Latches

Project:	
Catalog#:	
Approved by:	

White Plastic

Stainless Steel

- withstands corrosive environments

Stainless Steel Mounting Brackets
come standard with every fixture

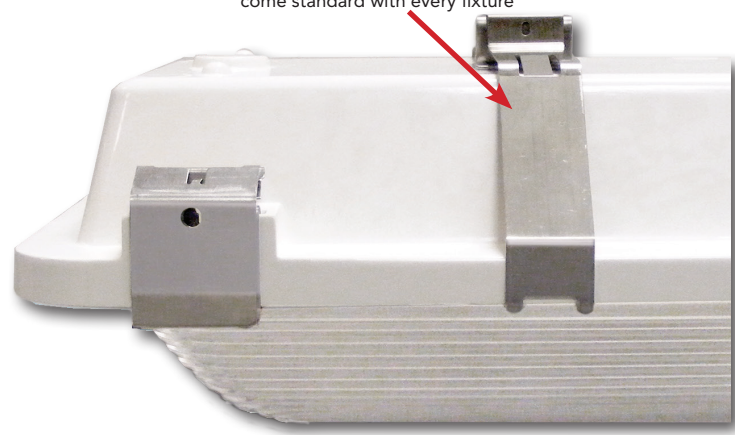
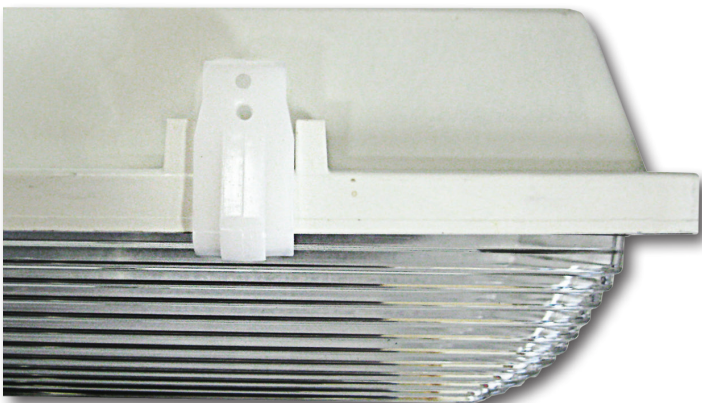

White Plastic Latch locks open during maintenance

Captive Keeper secures latch to housing preventing accidental loss of latch

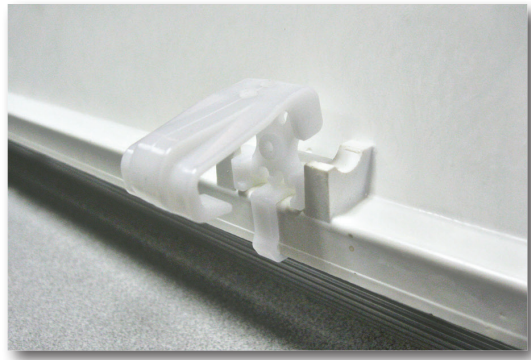

Keeper

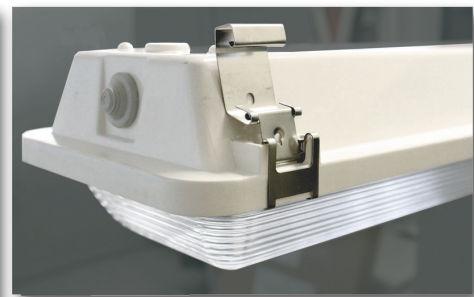

Latch Features:

Latches can be made Tamper Resistant with the addition of locking screws*

- White Plastic #4-32 x 1/2" Screws
- Stainless Steel #6-32 x 3/8" Screws

**Screws not included with the fixture

Stainless Steel Mounting Brackets
(Model# VSAX-MB-2L-2)
Come standard with every fixture

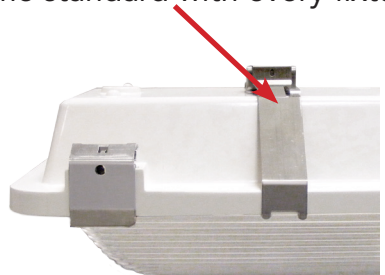

Specifications subject to change without notice.

2/22/2015

Vaporproof Fluorescent

Photometric Data - 4 Lamp T8 (VSA8A432ASE)

Iso Footcandle Plot

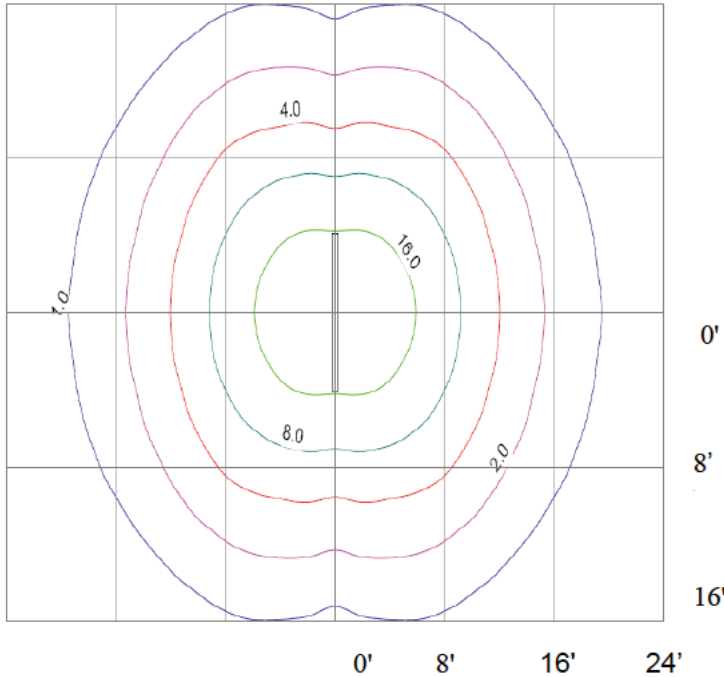

8' Mounting Height
Ballast: EP4/32IS/MV/MC/HE (Standard Ballast Factor)
Lamps: Four Howard F32T8/841/ECO/IC

Project:	
Catalog#:	
Approved by:	

Operating Temperatures

Number of Lamps	Lamp Type	Ballast Factor	Acceptable Temperature Range C (min-max)	Acceptable Temperature Range F (min-max)
2	T5	Standard	-30 to 45	-20 to 115
4	T5	Standard	-30 to 35	-20 to 95
6	T5	Standard	-30 to 25	-20 to 77
2	T8	High	-15 to 45	0 to 115
4	T8	High	-15 to 30	0 to 85
6	T8	High	-15 to 25	0 to 77
2	T8	Standard	-15 to 55	0 to 130
4	T8	Standard	-15 to 30	0 to 85
6	T8	Standard	-15 to 35	0 to 95

Zonal Lumen Summary

Zone	Lumens	%Lamp	%Fix
0-30	871	15	19
0-40	1481	26	32
0-60	2836	50	62
0-90	4299	75	94
90-120	263	5	6
90-150	293	5	6
90-180	294	5	6
0-180	4593	81	100

Coefficients of Utilization - Zonal Cavity Method

Effective floor cavity reflectance 20%														
RC	80				70				50			30		
RW	70	50	30	10	70	50	30	10	50	30	10	50	30	10
0	95	95	95	95	92	92	92	92	87	87	87	82	82	82
1	84	79	75	71	81	77	73	69	72	69	66	68	65	63
2	75	67	61	55	72	65	59	54	62	57	52	58	54	50
3	68	58	51	45	65	57	50	44	53	47	43	50	45	41
4	62	51	43	37	59	50	42	37	47	40	35	44	39	34
5	57	45	37	31	54	44	37	31	42	35	30	39	34	29
6	52	40	33	27	50	39	32	27	37	31	26	35	30	25
7	48	36	29	24	46	36	28	23	34	27	23	32	26	22
8	45	33	26	21	43	32	25	21	31	25	20	29	24	20
9	42	30	23	19	40	30	23	18	28	22	18	27	22	18

Specifications subject to change without notice.