

# CRLC SERIES COMMERCIAL INDOOR LIGHTING

**WESTGATE**  
THE FUTURE IS HERE...AND IT'S QUITE BRIGHT!

CRLC6-15W-MCT-S-D  
CRLC6-15W-MCT-S-D-WH  
6" LED COMMERCIAL SQUARE & OPEN RECESSED LIGHT



Ideal for hotel, offices, retail outlets, restaurant, parking garages, conference room, education facilities and more.

Customer Name: \_\_\_\_\_

Project Name: \_\_\_\_\_

Note: \_\_\_\_\_ Type: \_\_\_\_\_

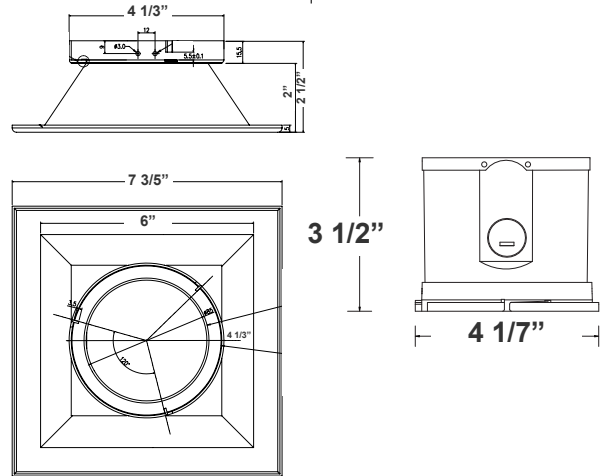

6"(H) X 4 1/7" (W)

## Features

- 6" Haze & White Finish TRIM
- MCT: The switch is on the light engine
- Mounting Options: Recessed
- 5-Year Warranty
- Lifespan: 50,000 hrs.

## Technical Specifications

### Electrical:

- Voltage: 120-277VAC 50/60Hz
- Wattage: 15W
- Power factor: >0.90
- Efficacy: 85 LPW

### Mechanical:

- 6" Haze & White Finish TRIM
- Mounting Options: Recessed
- Temperature Rating: Designed to operate in temperatures 113°F
- No IC-Rated
- Suitable for Damp Locations
- 5-Year Warranty

### Lighting:

- MCT: The switch is on the light engine
- Dimming: 0~10V Dimmable
- Total lumens: 1275LM
- Color temperature: 3000K/4000K/5000K
- Color rendering index: >80
- Lifespan: 50,000 hrs.

### Applications:

- Ideal for hotel, offices, retail outlets, restaurant, parking garages, conference room, education facilities and more.

### Other Models:

- 20W | 1720LM | CRLC6-20W-MCT-S-D
- 20W | 1720LM | CRLC6-20W-MCT-S-D-WH



Phone: (877) 805-2252 | Fax: (877) 805-2252  
www.westgatemfg.com



## Photometrics: CRLC6-15W-MCT-S-D

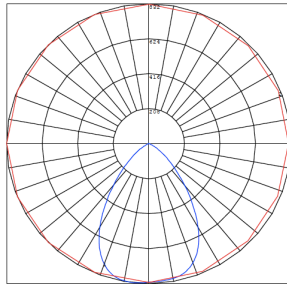

BUG Rating: B1-U1-G0

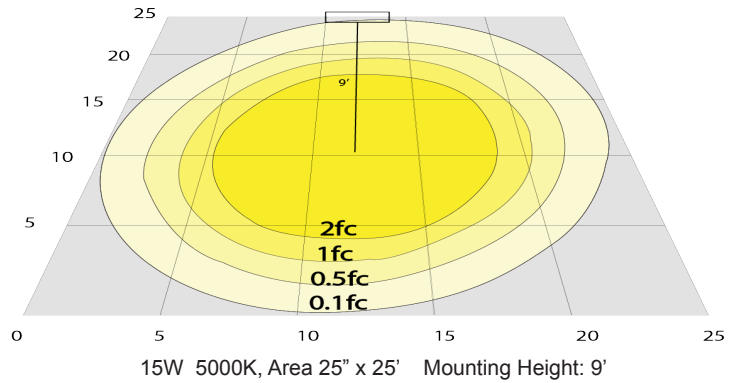

15W 5000K, Area 25" x 25" Mounting Height: 9'

## Other Views:

Hazel



CRLC-EGN-15W-MCT-D

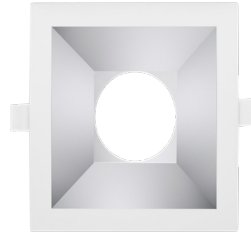

CRLC-TRM-6S



CRLC6-15W-MCT-S-D

White



CRLC-EGN-15W-MCT-D

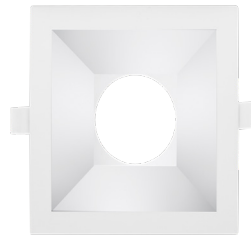

CRLC-TRM-6S-WH



CRLC6-15W-MCT-S-D-WH

## Performance Table: CRLC4-15W-MCT-S-D

| MODEL NO.            | Wattage | Voltage  | Lumens | Color Temp. | BUG Rating | LPW |
|----------------------|---------|----------|--------|-------------|------------|-----|
| CRLC6-15W-MCT-S-D    | 15W     | 120-277V | 1275LM | 3000K       | B1-U1-G0   | 85  |
| CRLC6-15W-MCT-S-D-WH |         |          |        | 4000K       |            |     |
|                      |         |          |        | 5000K       |            |     |

## Sample Ordering

Model Watt Shape Dimming Housing

CRLC6 - 15W - MCT - S - D -

Blank  
WH = WHITE

### Accessory:

Blank = No Option For Accessories  
SSL6-RI = 6" SQUARE ROUGH-IN PLATE, 26" LONG

### Factory-Installed Option:

Blank = No Option For Accessories  
OPT-EM-HB1EXT = EXTERNAL EMERGENCY BACK UP BATTERY

### Accessory:

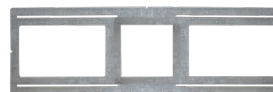

SSL6-RI  
6" SQUARE ROUGH-IN  
PLATE, 26" LONG

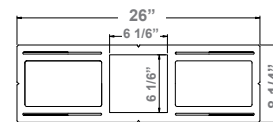

SSL6-RI  
26"(W) x 8 1/4"(H)

### Factory-Installed Option:



OPT-EM-HB1EXT  
EXTERNAL EMERGENCY  
BACK UP BATTERY

## Example:

1. CRLC6-15W-MCT-S-D (FOR 15W CRLC6 MCT 120-277V)

1. CRLC6-15W-MCT-S-D (FOR 15W CRLC6 MCT 120-277V)  
OPT-EM-HB1EXT (EXTERNAL EMERGENCY BACK UP BATTERY)

