

SOLR SERIES Outdoor Lighting

SOLR-WL2-MCT-SEN
SOLAR ROADWAY STUD LIGHT
MCT Multi Color Temperature (Selectable)

Customer Name: _____

Project Name: _____

Note: _____ | Type: _____

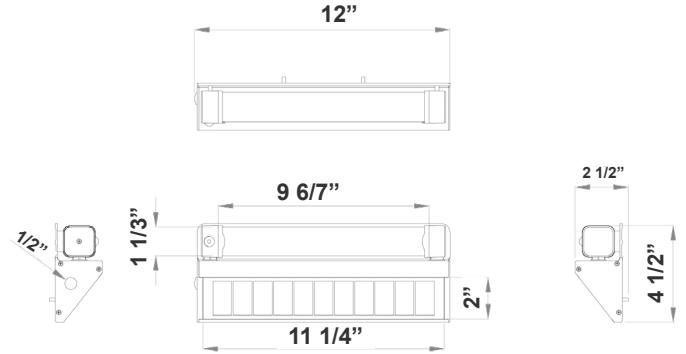
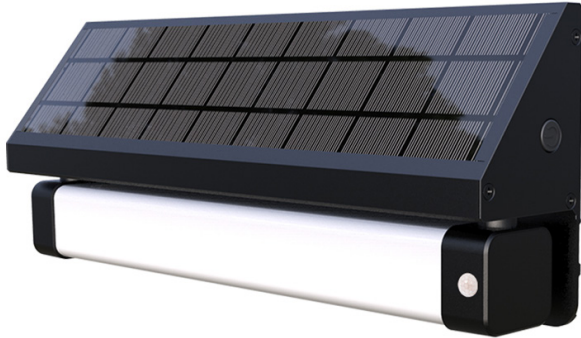

4 1/2"(H) X 12"(W) X 2 1/2"(D)

Ideal for general site lighting, alleys, loading docks, doorway, pathway, and parking areas.

Features

- 7-Year Warranty
- Robust Aluminum Alloy + Polycarbonate Cover
- Lifespan: 70000 Hrs.
- Lens: TYPE III Optic Lens

Technical Specifications

Electrical:

- LED Wattage: 8W
- Power Factor: 0.95
- Efficacy: 125LM/W

Mechanical:

- Operating Temperature: 14°F to 122°F
- IP Rating: IP65

Battery:

- Operation on Full Charge: 6-8 hrs. Depending on the Sunlight Quality, See The Map On Page 3
- Battery Type: Lithium-ion 5200mAh
- Battery Life: More than 2000 Cycles (2000/365 days = 5.47 years) With Overcharge And Over-Discharge Protection

Lighting:

- Lens: TYPE III Optic Lens
- LED: Lumileds Luxeon 5050
- Total Lumens: 1000LM
- Color Temperature: 3000K/6000K
- Color Rendering Index: >70
- Lifespan: 70000 Hrs.

Applications:

- Ideal for Ideal for doorway, pathway and alleys
- Great for use with optional motion sensors or photocell

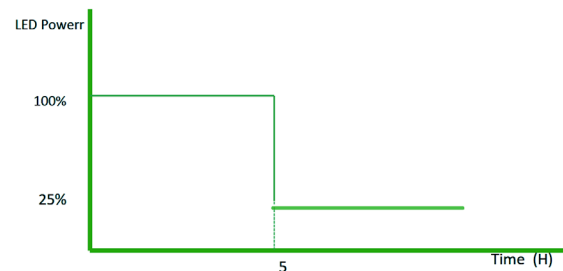

Working mode:
Dusk to Dawn
Full Brightness for First 5Hrs.
Dim to 25% for 7Hrs.



Photometrics: SOLR-WL2-MCT-SEN

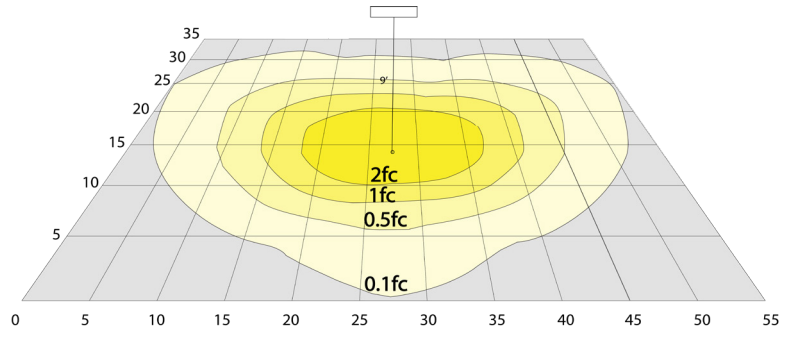
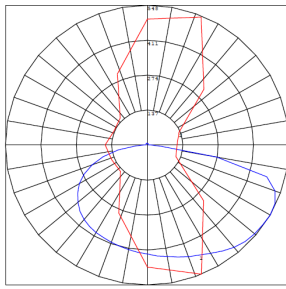
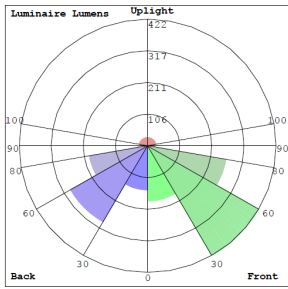

BUG Rating: B1-U2-G0

Area 35'x 55' Mounting Height: 9'

Other Views:



Side View



Front View



Back View

Performance Table: SOLR-WL2-MCT-SEN

MODEL NO.	LED WATTS	Lumens	Color Temp.	BUG Rating	LPW
SOLR-WL2-MCT-SEN	8W	1000LM	3000K 6000K	B1-U2-G0	125

Sample Ordering

Model	Style	Color Temp.	Sensor
SOLR	WL2	MCT	SEN



Average Daily Solar Radiation Per Month:

Increasing the tilt 15° in the winter or decreasing 15° in the summer gives the maximum sunlight for recharging the battery.

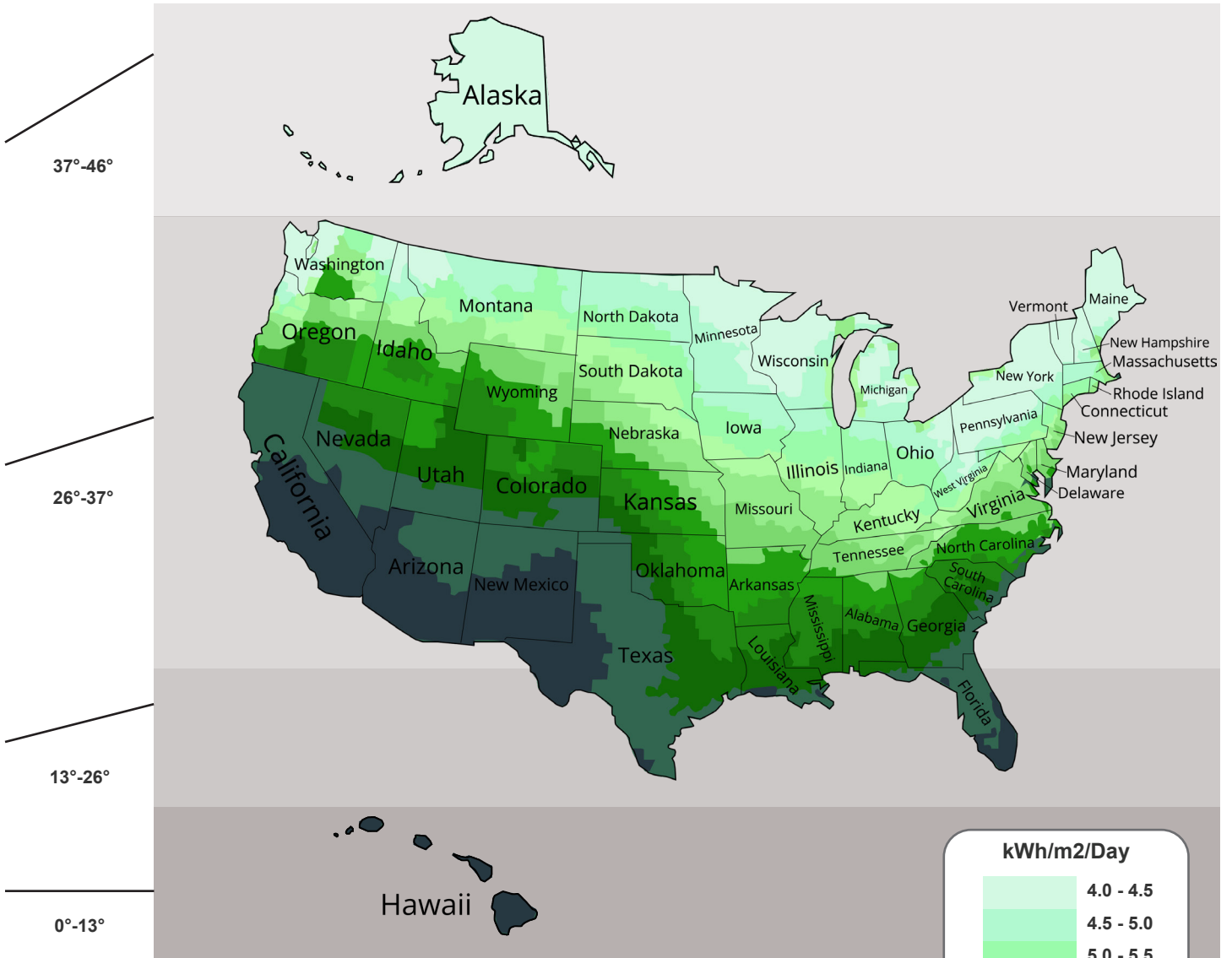

- The best facing direction for the solar panel is toward the south. facing west & east & north will provide less sunlight, resulting in a long time to charge the battery. The solar charge will be less optimal if the installation is facing north.

