

UHX-230W-MCTP-WH

Customer Name: _____

Project Name: _____

Note: _____

Type: _____

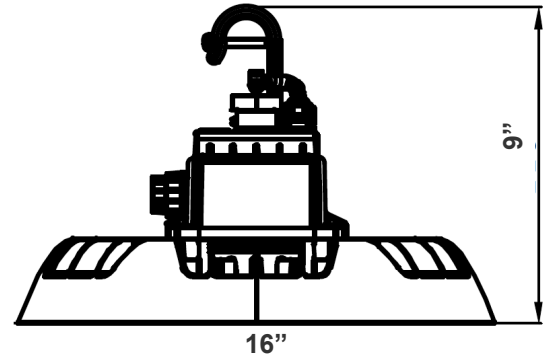

9" (H) X 16" (D)

In a aluminium shell designed for heat dissipation, UHX is IP65 water resistant rated and ideal for general site lighting, alleys, loading docks, doorways, pathways, parking areas, warehouses and storage buildings.

Features

- Waterproof design, suitable for wet locations
- ADC12 Aluminum Heat Sink, Outdoor Powder Coating Finish
- Optical Lens: PC Materials High Light Transmittance, Anti-UV, Fire-Resistant
- Multi Color Temperature & Multi Power (Selectable Switch Located On The Driver Housing)

Technical Specifications

Electrical:

- Input Wattage: 100W/150W/200W/230W
- Input Voltage: 120-277VAC 50/60Hz
- Power Factor: >0.9
- THD: <20%
- Efficacy: 130 LPW

Mechanical:

- ADC12 Aluminum Heat Sink, Outdoor Powder Coating Finish
- Optical Lens: PC Materials High Light Transmittance, Anti-UV, Fire-Resistant
- 3' SJTW 18,3 AWG Power Cable
- 6' SJTW Dimming Cable
- LED: LUMILEDS 2835
- LED PCB Board: High Conductive, Waterproof, Aging Resistance, salt mist Resistance, Ensure the Safety and Long Lifespan
- Operating temperature: -40°F to 122°F
- IP rating: IP65, Wet Locations
- Lifespan: 50,000 Hrs

Lighting:

- Dimming: 0~10V
- Multi Color Temperature & Multi Power (Selectable Switch Located On The Driver Housing)
- Total Lumens: 13000/19500/26000/29900 LM
- Color Temperatures: 3000K/ 4000K/ 5000K/ 5700K
- Color Rendering index: > 80
- Beam Angle: 90°
- Lifespan: 50,000 Hrs

Applications:

- Ideal for general site lighting, alleys, loading docks, doorway, pathway, parking areas, warehouses and storage buildings.

Other Models:

- 150W | 18750 LM | UHX-150W-MCTP-WH



Photometrics: UHX-230W-MCTP-WH

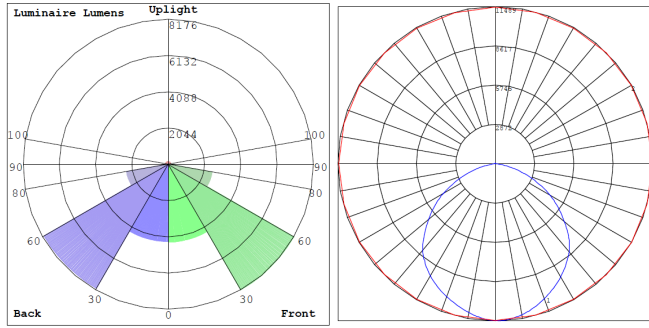

BUG Rating: B4-U3-G2

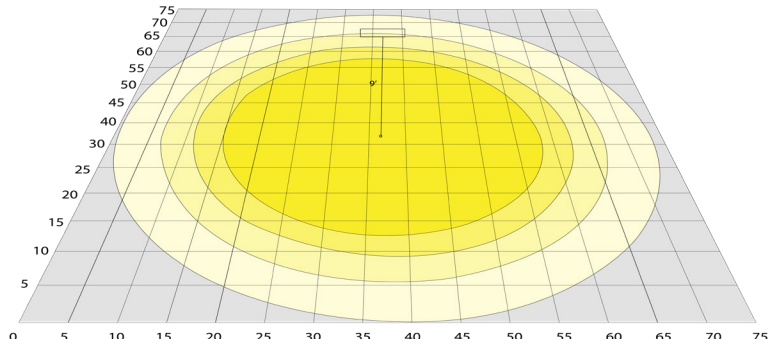

Area 75'x 75' Mounting Height: 9'

Other Views:



Side View



Top View

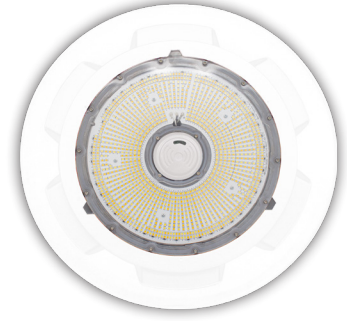

Bottom View

Performance Table: UHX-230W-MCTP-WH

MODEL NO.	Wattage	Voltage	Lumens	Color Temp	BUG Rating	LPW
UHX-230W-MCTP-WH	100W	120-277V	13000LM	3000K	B4-U3-G2	130
	150W		19500LM	4000K		
	200W		26000LM	5000K		
	230W		29900LM	5700K		

Sample Ordering

Model Wattage Color Temp. Housing

UHX - 230W - MCTP - WH

Accessory

Blank = No Accessory
 HB-RING = HIGHBAY TOP RING ADAPTER, 1/2in
 HB-EB-50/75 = HIGHBAY EXPANSION BUSHING FROM 1/2in TO 3/4"
 UHX-SMB = UHX SERIES SURFACE MOUNTING YOKE BRACKET
 UHX-WG-A = UHX SERIES WIRE GUARD, FITS ON FIXTURES
 UHX-SC = UHX SERIES 22" SAFETY CABLE
 UHX-ALR-B = 60° UHX SERIES ALUM. REFLECTOR
 UHX-ALRW-B = 90° ALUM. REFLECTOR FOR 230W (MCTP ONLY) & 300W MP
 UHX-PCR-B = UHX SERIES PRISMATIC PC REFLECTOR
 UHX-PCDC = UHX SERIES PC DROP LENS COVER FOR REFLECTORS
 UHX-PCC = UHX SERIES PC BOTTOM COVER FOR REFLECTORS
 UHX-FL-B = UHX SERIES REPLACEMENT FROSTED GLASS LENS
 UHX-SA-5057 = 1/2 IN STEM-MOUNTING ADAPTER WITH CABLE PASSAGE AND 1/2 IN THREADED TOP. 3/4" THREADED ADAPTER

Factory-Installed Option:

Blank = No Accessory
 OPT-EM-UHX = EXTERNAL EMERGENCY BACKUP BATTERY INSTALLED ON TOP OF THE FIXTURE
 OPT-HBC=125TL-WH = NEMA TWIST-LOCK PLUG 8FT, 15A, 125V, 16/3TL, WHT
 OPT-HBC=277TL-WH = NEMA TWIST-LOCK PLUG 8FT, 15A, 277V, 16/3TL, WHT
 OPT-HBC=125SB-WH = STRAIGHT BLADE PLUG 10FT, 15A, 125V, 18/3TL, WHT
 OPT-SEN-UHX = MICROWAVE BI-LEVEL SENSOR

Example:

1. UHX-230W-MCTP-WH (FOR UHX 230W MCTP WHITE FIXTURE 120-277V)
2. UHX-230W-MCTP-WH HB-RING (FOR UHX 230W MCTP WHITE FIXTURE 120-277V) (HIGHBAY TOP RING ADAPTER, 1/2in)



ACCESSORIES:



UHX-PCR-B
UHX SERIES
PRISMATIC PC
ALUM. REFLECTOR
FOR UP TO 230W



UHX-ALR-B
UHX SERIES 60° ALUM
REFLECTOR FOR UP
TO 300W



UHX-PCC
UHX SERIES PC
BOTTOM COVER FOR
REFLECTORS



UHX-PCDC
UHX SERIES PC DROP
LENS COVER FOR
REFLECTORS



UHX-ALRW-B
90° ALUM.
REFLECTOR FOR
230W (MCTP ONLY)
& 300W MP



HB-RING
HIGHBAY TOP RING
ADAPTER, 1/2in



HB-EB-50/75
HIGHBAY EXPANSION
BUSHING FROM 1/2in TO
3/4"



UHX-SMB
UHX SERIES SURFACE
MOUNTING YOKE
BRACKET
(Can be painted)



UXH-FL-B
UHX SERIES
REPLACEMENT FROSTED
GLASS LENS



UHX-SC
UHX SERIES SAFETY
CABLE

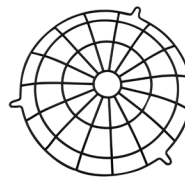

UHX-WG-A
UHX SERIES WIRE
GUARD, FITS ON
FIXTURES



UHX-SA-5075
1/2 IN STEM-MOUNTING
ADAPTER WITH CABLE
PASSAGE AND 1/2 IN THREADED
TOP. 3/4 IN THREADED ADAPTER
INCLUDED

FACTORY-INSTALLED OPTION:



OPT-HBC-125SB-WH
STRAIGHT BLADE PLUG 10FT, 15A,
125V, 18/3TL, WHT



OPT-HBC-125TL-WH
NEMA TWIST-LOCK PLUG 8FT, 15A,
125V, 16/3TL, WHT



OPT-HBC-277TL-WH
NEMA TWIST-LOCK PLUG 8FT, 15A,
277V, 16/3TL, WHT



OPT-EM-UHX
EXTERNAL EMERGENCY
BACKUP BATTERY INSTALLED
ON TOP OF THE FIXTURE
(The bracket can be painted)



Dimensions:



UHX-PCC
UHX SERIES PC BOTTOM COVER
FOR 60° REFLECTORS

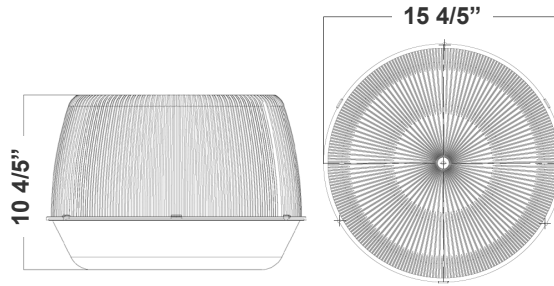

UHX-ALR-B
UHX SERIES 60° ALUM.
REFLECTOR

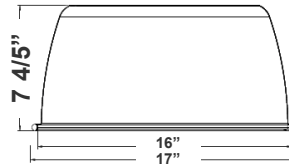

UHX-ALRW-B
90° ALUM. REFLECTOR FOR 230W
(MCTP ONLY) & 300W MP

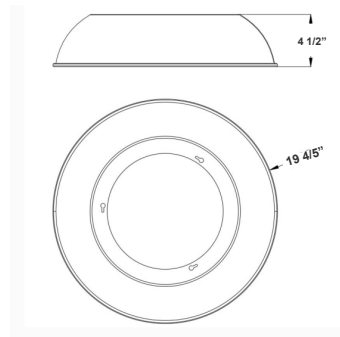

UHX-PCR-B
UHX SERIES PRISMATIC PC
REFLECTOR

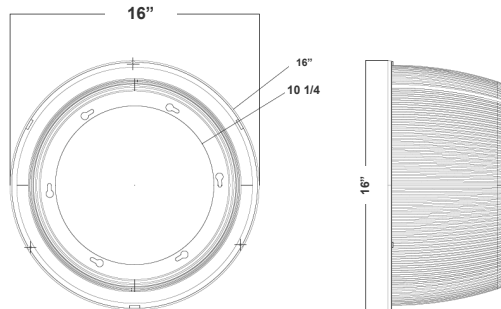

UHX-PCDC
UHX SERIES PC DROP LENS
COVER FOR REFLECTORS

