

LED Full Cut-Off Wall Pack Series

Wattages: 45W, 70W / Tunable Wattages: 30W/45W/60W/70W

LED Full Cut-Off Wall Pack series can be widely used in indoor or outdoor lighting (wet location). Ideal for mechanical or electronic processing workshops, storage warehouses, steel mills, gas stations, toll booth, waiting rooms, the platforms of railway station, indoor stadiums.



WATT/CCT
FIELD-ADJUSTABLE

FEATURES

- Lumileds LED, high luminous efficiency and long working life.
- High efficiency LED Driver, the wide range input voltage AC120-277V/AC 347V.
- Excellent optics design, greatly improve the light utilization and evenness.
- Motion sensor control available (Optional)
- 1-10V Dimming.

Die-cast aluminum cooling design, high quality and better cooling for LED Tj < 85°C.



SPECIFICATION			
WATTAGE	45W	70W	30W/45W/60W/70W
LUMEN	6756 lm	10500 lm	4216 / 6139 / 7882 / 8980 lm
EFFICACY	150 lm/W	150 lm/W	130 lm/W
CCT	4000K, 5000K		3000K/4000K/5000K
CRI	70		70
INPUT VOLTAGE	120-277V / 347V	120-277V	120-277V
POWER FACTOR	0.95		0.95
DRIVER EFFICACY	90%		90%
DIMMING	1-10V Dimming		1-10V Dimming
LIGHT ANGLE	82° X 102°		
LIFE SPAN	75,000 hrs		
WORKING TEMPERATURE	-22°F ~ 113°F		
STORAGE TEMPERATURE	-40°F ~ 176°F		
OUTDOOR RATING	Wet location		
CABLE	Input Connect, No cable		
WARRANTY	5 year limited		

LED Full Cut-Off Wall Pack Series

Wattages: 45W, 70W / Tunable Wattages: 30W/45W/60W/70W

DIMENSION

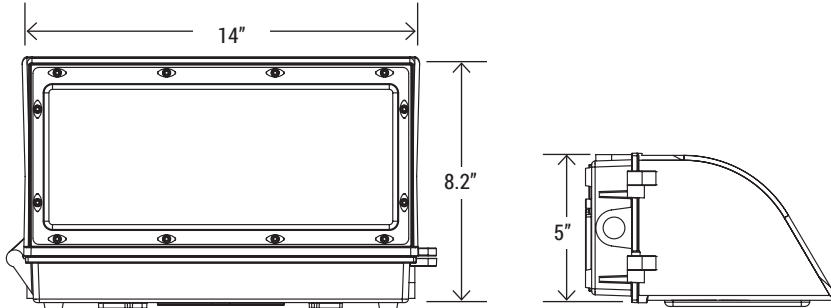

WATTAGE	45W
NT. WEIGHT	6.4 lbs/carton
BOX DIM.	14" x 8.2" x 5"

WATTAGE	70W
NT. WEIGHT	6.61 lbs/carton
BOX DIM.	14" x 8.2" x 5"

WATTAGE	30W/45W/60W/70W
NT. WEIGHT	6.26 lbs/carton
BOX DIM.	14" x 8.2" x 5"

EMERGENCY BACK-UP (SOLD SEPARATELY)



BLD-CM20N-480800-8W
8W Emergency Backup Battery
LED Driver

BLD-CM20N-480800-15W
15W Emergency Backup Battery
LED Driver

BLD-CM20N-480800-20W
20W Emergency Backup Battery
LED Driver

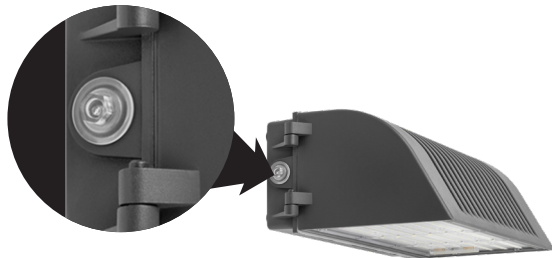

CONTROLS (SOLD SEPARATELY)
P (Photocell)



WATT/CCT
FIELD-ADJUSTABLE

ORDERING INFORMATION

EXAMPLE:

WSD-FWP-07W-27-50K-P

WSD	FWP	07W	27	50K	D	P
COMPANY	PRODUCT	WATTAGE	VOLTAGE	CCT	FINISH	CONTROL
WSD LED INC	FWP Full Cut-Off Wall Pack	*45W - (45W) 07W - (70W) 34567W - (30W/45W/ 60W/70W)	27 (AC120-277V) *347 (AC347V)	40K - (4000K) 50K - (5000K) 345K - (3000K/4000K/5000K)	D - (Dark Bronze) W - (White) B - (Black) S - (Silver)	P - (Photocell)

LED Full Cut-Off Wall Pack Series

Wattages: 45W, 70W / Tunable Wattages: 30W/45W/60W/70W

PHOTOMETRICS

For complete IES files, please visit our website.

WSD-FWP-45W-50K

LUMINOUS INTENSITY DISTRIBUTION DIAGRAM

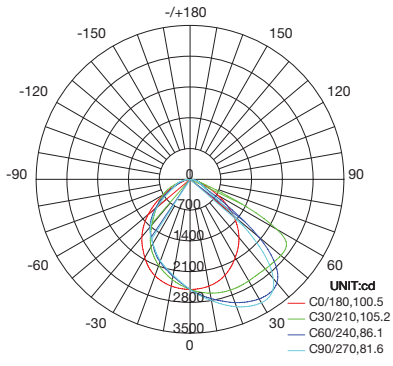

AVERAGE BEAM ANGLE(50%): 93.4 DEG

C0 PLANE ISOLUX DIAGRAM (UNIT:lx)

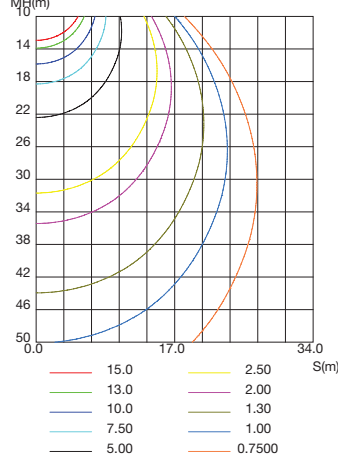

ISOLUX DIAGRAM

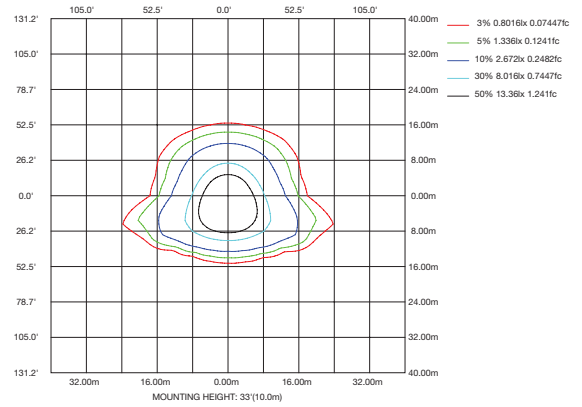

WSD-FWP-70W-50K

LUMINOUS INTENSITY DISTRIBUTION DIAGRAM

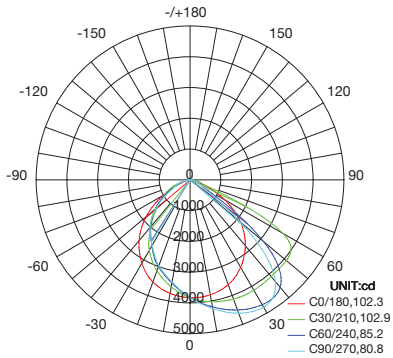

AVERAGE BEAM ANGLE(50%): 92.8 DEG

C0 PLANE ISOLUX DIAGRAM (UNIT:lx)

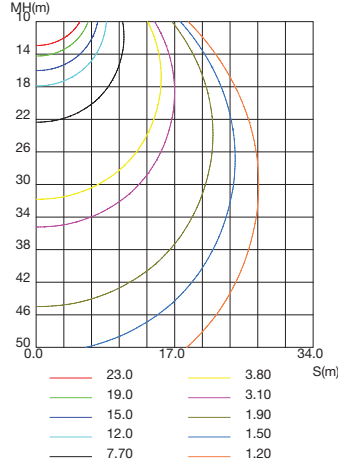

ISOLUX DIAGRAM

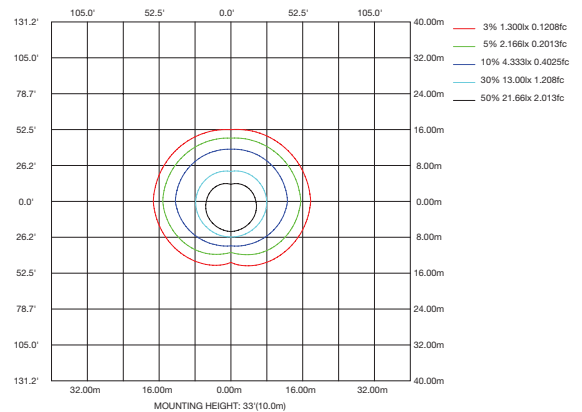

WSD-FWP-34567W-50K (SHOWN IS 70W@5000K)

LUMINOUS INTENSITY DISTRIBUTION DIAGRAM

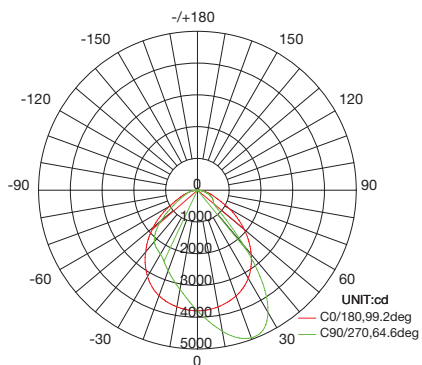

AVERAGE BEAM ANGLE(50%): 81.9 DEG

C0 PLANE ISOLUX DIAGRAM (UNIT:lx)

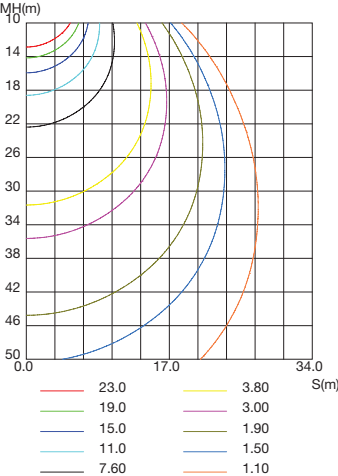

ISOLUX DIAGRAM

