

# LED Vapor Tight Series

**Wattages: 25W, 45W / Tunable Wattages: 30W/45W/60W/70W**



The Vapor Tight Series provides gasketed enclosure which provides dust-free and moisture-free fixture. The Vapor Tight Series can be widely used for food processing plants, meat lockers, beverage coolers, car washes, and parking structures.



## FEATURES

- Made of high quality ABS material, high ignition point, more safe.
- With PC lens.
- Lampshade-inner surface stripe design make the light diffusion angle greater and the light more uniform.
- 1-10V dimming.

**WATT/CCT**  
**FIELD-ADJUSTABLE**

Simply select desired CCT and Wattage before installation



SPECIFICATION			
WATTAGE	(2FT) 25W	(4FT) 45W	(8FT) 30W/45W/60W/70W
LUMEN	3550 Lm	6390 lm	4562 lm/6699 lm/8705 lm/10330 lm
EFFICACY	142 lm/W	142 lm/W	up to 147 lm/W
CCT	4000K, 5000K		3000K/4000K/5000K
CRI	80		
INPUT VOLTAGE	AC120-277V		
LIGHT ANGLE	118°		122°
POWER FACTOR	0.95		
DRIVER EFFICACY	90%		
DIMMING	1-10V Dimming		
WORKING TEMPERATURE	-22°F ~ 113°F		
LIFESPAN (L70)	75,000 hours		
PROTECTION LEVEL	Wet locations		
CABLE	3 core, 18AWG (0.5m)		
WARRANTY	5 year limited		

# LED Vapor Tight Series

**Wattages: 25W, 45W / Tunable Wattages: 30W/45W/60W/70W**

## DIMENSION

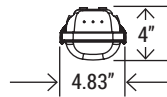
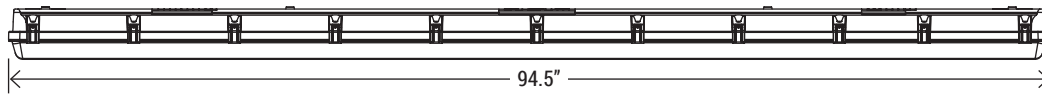
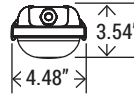
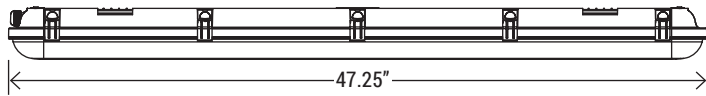
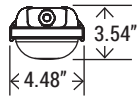
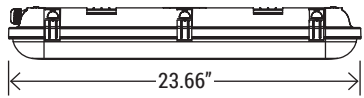

**2'**  
FIXTURE

<b>WATTAGE</b>	25W
<b>GR. WEIGHT</b>	3.8 lbs (4 pcs/carton)
<b>BOX DIM.</b>	25.4" x 7.3" x 6.5"

**4'**  
FIXTURE

<b>WATTAGE</b>	45W
<b>GR. WEIGHT</b>	6.5 lbs (4 pcs/carton)
<b>BOX DIM.</b>	49.2" x 7.3" x 6.5"

**8'**  
FIXTURE

<b>WATTAGE</b>	30W/45W/60W/70W
<b>GR. WEIGHT</b>	11.77 lbs (4 pcs/carton)
<b>BOX DIM.</b>	96.5" x 5.7" x 4.7"

## EMERGENCY BACK-UP (SOLD SEPARATELY)



**BLD-CM20N-480800-8W**  
8W Emergency Backup Battery  
LED Driver

**BLD-CM20N-480800-15W**  
15W Emergency Backup Battery  
LED Driver

**BLD-CM20N-480800-20W**  
20W Emergency Backup Battery  
LED Driver

## CONTROL (SOLD SEPARATELY)



**BRI810 // BRI810-B-M6**  
Microwave Motion Sensor



**RC-100**  
Microwave Sensor  
Remote Controller

## ORDERING INFORMATION

EXAMPLE:

**WSD-VP2FT25W27-50K-W**

WSD	VP	2FT	25W	27	50K	G
PRODUCT	PRODUCT	SIZE	WATTAGE	VOLTAGE	CCT	FINISH
WSD (WSD LED INC)	VP (Vapor Tight)	2FT (2-foot)	25W - (25W)	27 - (120-277V)	40K - (4000K) 50K - (5000K)	G - (Gray)
		4FT (4-foot)	45W - (45W)			
		8FT (8-foot)	34567W - (30W/45W/60W/70W)		345K - (3000K/4000K/5000K)	

# LED Vapor Tight Series

**Wattages: 25W, 45W / Tunable Wattages: 30W/45W/60W/70W**

## PHOTOMETRICS

For complete IES files, please visit our website.

### WSD-VP-2FT25W-27-50K

LUMINOUS INTENSITY DISTRIBUTION DIAGRAM

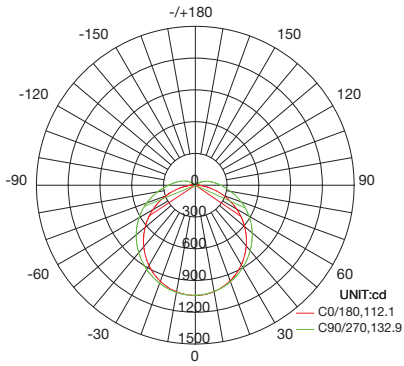

AVERAGE BEAM ANGLE(50%):122.5 DEG

C0 PLANE ISOLUX DIAGRAM (UNIT:lx)

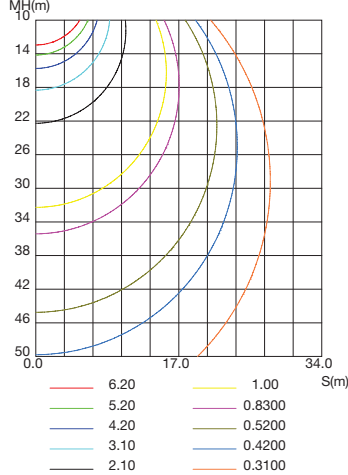

ISOLUX DIAGRAM

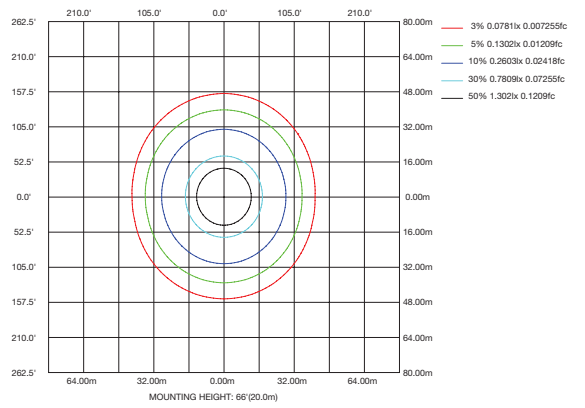

### WSD-VP-4FT45W-27-50K

LUMINOUS INTENSITY DISTRIBUTION DIAGRAM

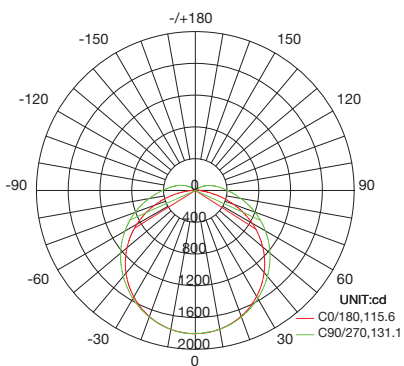

AVERAGE BEAM ANGLE(50%):123.3 DEG

C0 PLANE ISOLUX DIAGRAM (UNIT:lx)

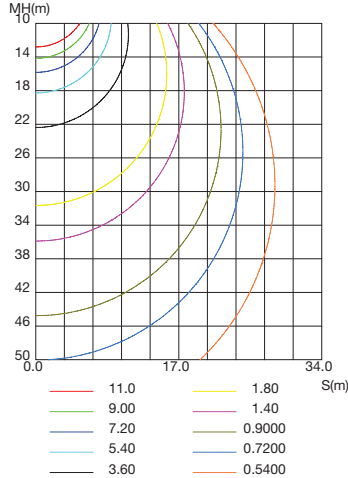

ISOLUX DIAGRAM

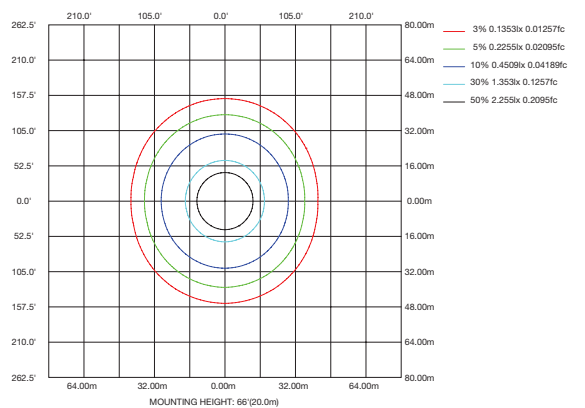

### WSD-VP-8FT30W-27-50K

LUMINOUS INTENSITY DISTRIBUTION DIAGRAM

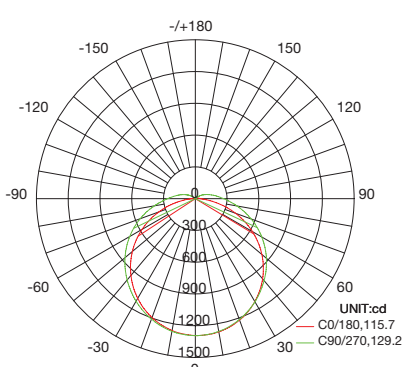

AVERAGE BEAM ANGLE(50%):122.4 DEG

C0 PLANE ISOLUX DIAGRAM (UNIT:lx)

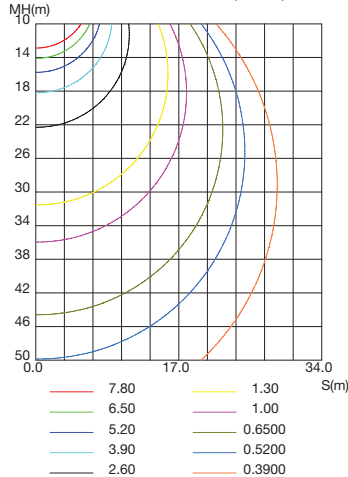

ISOLUX DIAGRAM

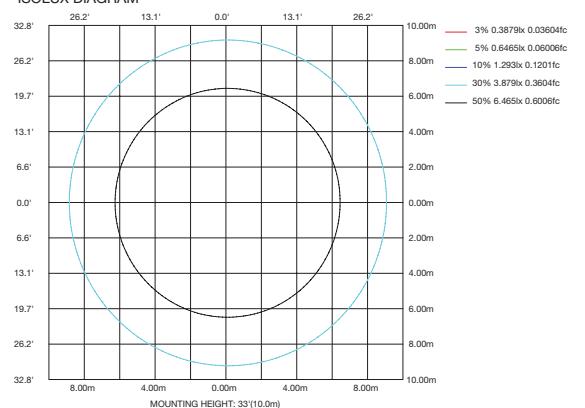

# LED Vapor Tight Series

Wattages: 25W, 45W / Tunable Wattages: 30W/45W/60W/70W

## PHOTOMETRICS

For complete IES files, please visit our website.

### WSD-VP-8FT45W-27-50K

LUMINOUS INTENSITY DISTRIBUTION DIAGRAM

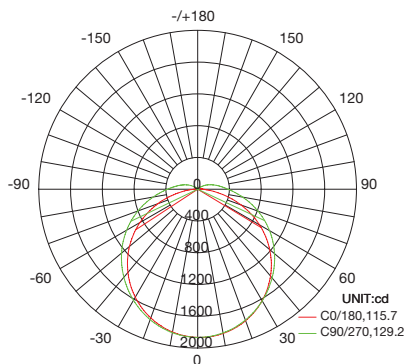

AVERAGE BEAM ANGLE(50%):122.4 DEG

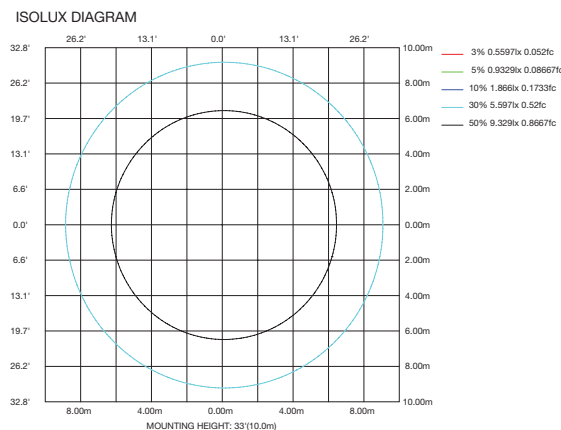
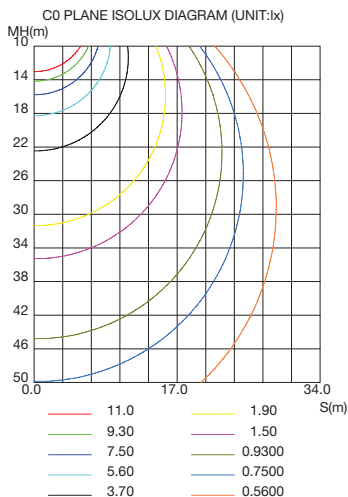

### WSD-VP-8FT60W-27-50K

LUMINOUS INTENSITY DISTRIBUTION DIAGRAM

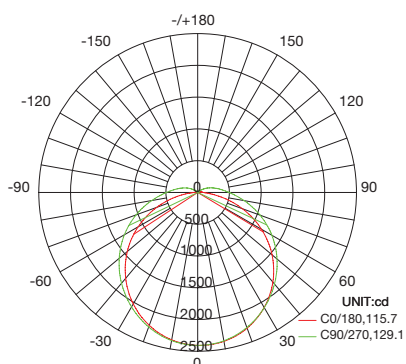

AVERAGE BEAM ANGLE(50%):122.4 DEG

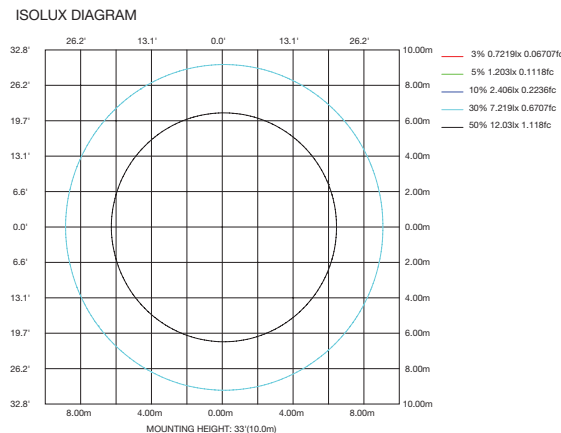
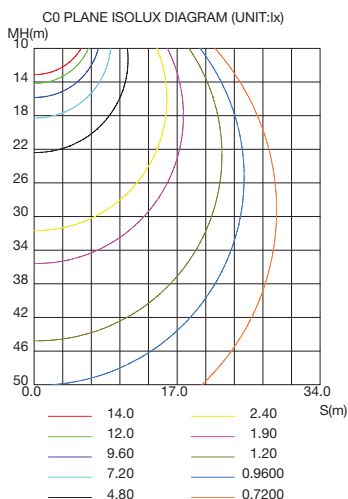

### WSD-VP-8FT70W-27-50K

LUMINOUS INTENSITY DISTRIBUTION DIAGRAM

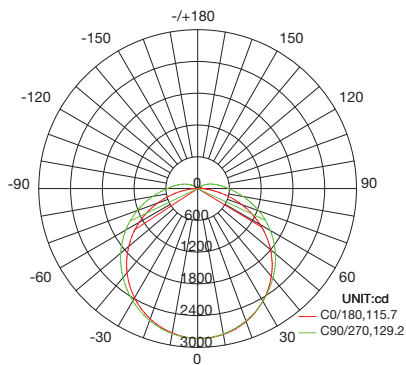

AVERAGE BEAM ANGLE(50%):122.4 DEG

