

4

3

2

1

B

B

A

A

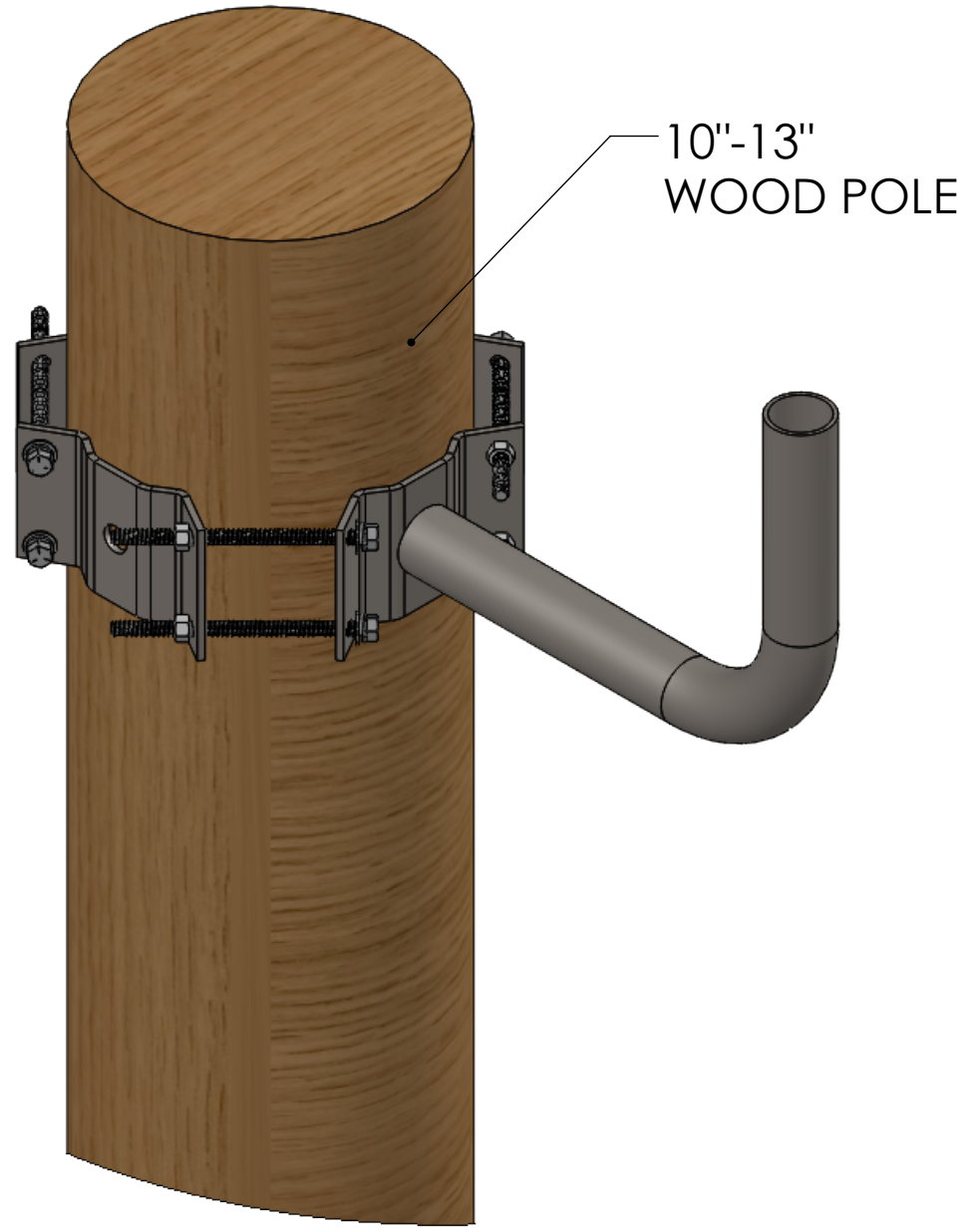
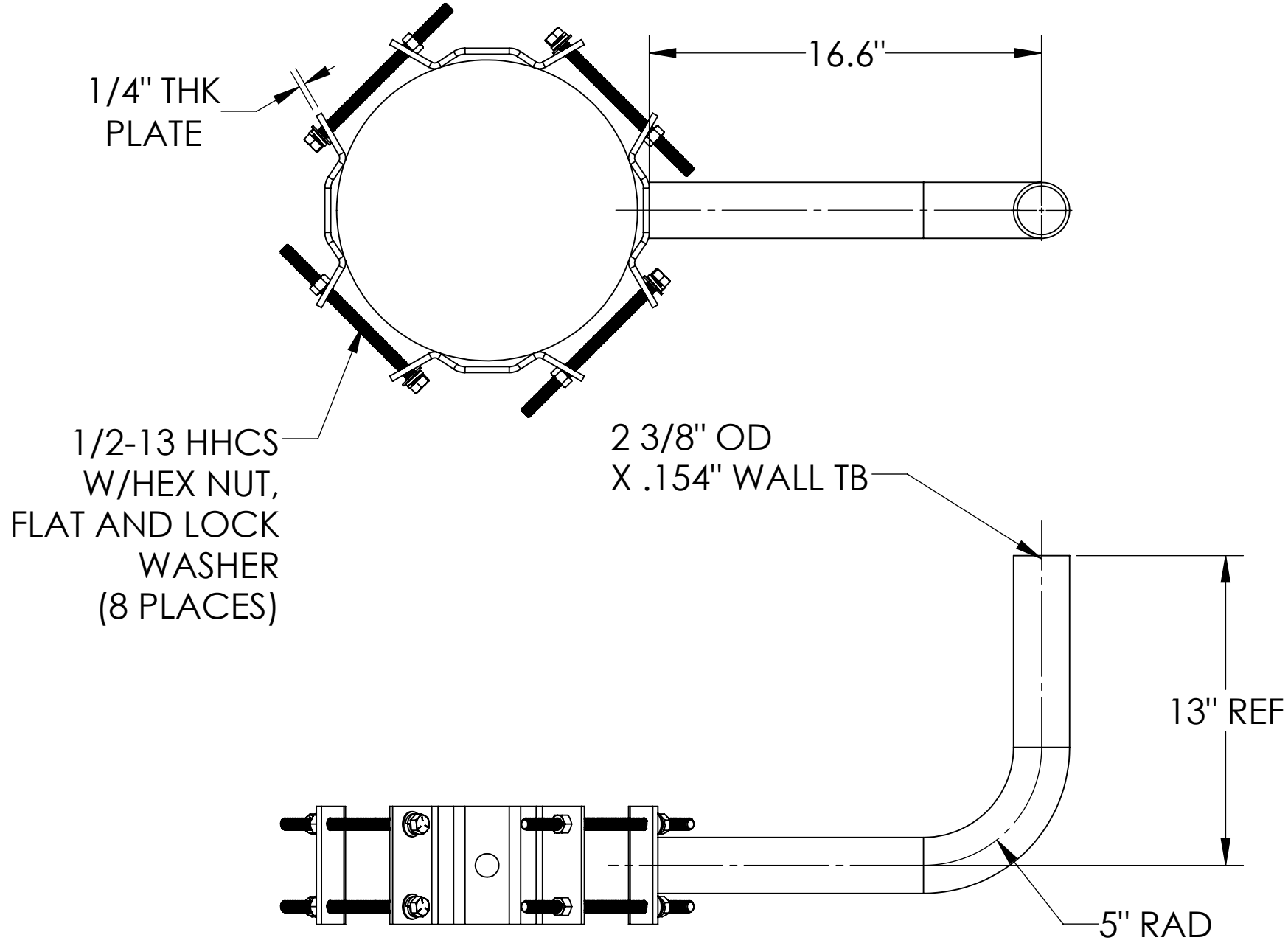

All dimensions and specifications are subject to change without any notice.

PROPRIETARY AND CONFIDENTIAL
 THE INFORMATION CONTAINED IN THIS DRAWING IS THE SOLE PROPERTY OF *Energy Light, Inc.* ANY REPRODUCTION IN PART OR AS A WHOLE WITHOUT THE WRITTEN PERMISSION OF *Energy Light, Inc.* IS PROHIBITED.

		UNLESS OTHERWISE SPECIFIED:		NAME	DATE	TITLE: 1 Arm Wrap Around Bracket for Wood Poles with 10-13 Inch Diameter					
		DIMENSIONS ARE IN INCHES		DRAWN	MKA			07-08-21			
		TOLERANCES: FRACTIONAL ± 1/64		ENG APPR.							
		ANGULAR: ± 0.5°		MFG APPR.							
		TWO PLACE DECIMAL ±0.01		Q.A.			SIZE	ITEM NO.	REV		
		THREE PLACE DECIMAL ±0.005		 Energy Light, Inc. 1881 Rose Road Lake Zurich, IL 60047			B	WPB1149			
		INTERPRET GEOMETRIC TOLERANCING PER:					SCALE: 1:6			WEIGHT: 21 lbs	SHEET 1 OF 1
		MATERIAL									
NEXT ASSY	USED ON	FINISH									
APPLICATION		DO NOT SCALE DRAWING									

4

3

2

1